

# ATR2600C User Manual

Version 2.3  
Apr 2025



All materials related to this publication are subject to change without notice and its copyright totally belongs to ToupTek Photonics.

Please download the latest version from [toupTek-astro.com](http://toupTek-astro.com).

## Contents

<b>ATR2600C User Manual .....</b>	<b>1</b>
<b>1 Description and Features.....</b>	<b>1</b>
<b>2 ATR2600C Specifications and Performance .....</b>	<b>2</b>
2.1 Camera Specifications .....	2
2.2 Sony IMX571 Sensitivity .....	3
2.3 16bit ADC and ROI .....	3
2.4 DDR3 Buffer.....	3
2.5 Binning .....	3
2.6 Conversion Gain Switch.....	3
2.7 Power and Cooling System for Precise Temperature Regulation.....	4
2.8 Zero Amp-Glow .....	4
2.9 Camera Performance Analysis.....	4
<b>3 Product Package and Connections .....</b>	<b>14</b>
3.1 Packing List .....	14
3.2 Camera Dimension and Its Mount.....	15
3.3 Camera Outline and Interface.....	16
3.4 Camera Mechanical Connection with Adapter .....	16
3.5 Camera Mechanical Connection with Lens.....	17
3.6 Camera Electric Connection with Accessories .....	18
<b>4 ATR2600C and Its Software .....</b>	<b>20</b>
4.1 Application Installation .....	20
4.1.1 <i>User-friendly UI Design</i> .....	20
4.1.2 <i>Professional Camera Control Panel</i> .....	21
4.1.3 <i>Practical Functions with Good Results</i> .....	22
4.1.4 <i>Powerful Compatibility</i> .....	22
4.1.5 <i>Hardware Requirement</i> .....	22
4.2 ATR2600C and Dshow .....	22
4.3 ATR2600C and the 3 <sup>rd</sup> Party Software .....	23
4.3.1 <i>Support Software</i> .....	23
4.3.2 <i>N.I.N.A</i> .....	23
4.3.3 <i>INDI</i> .....	23
4.3.4 <i>ASCOM Platform</i> .....	23
4.3.5 <i>PHD Guiding</i> .....	23
4.3.6 <i>Nebulosity</i> .....	23
4.3.7 <i>MetaGuide</i> .....	23
4.3.8 <i>MAXIMDL</i> .....	23
4.3.9 <i>AstroArt</i> .....	23
4.3.10 <i>FireCapture</i> .....	23
4.3.11 <i>SharpCap</i> .....	23
4.3.12 <i>Registax</i> .....	23
4.3.13 <i>AstroStack</i> .....	23
4.3.14 <i>DeepSky Stacker</i> .....	24
<b>5 Service.....</b>	<b>25</b>
ATR2600CATR2600CATR2600CATR2600CATR2600C	

# 1 Description and Features

The ATR2600C(ATR3CMOS26000KPA) camera is designed specifically for astrophotography. It is mainly used for deep sky photo shooting, since the camera has cooled CMOS sensor, ultra-low readout noise and zero amp-glow. It can be also used for planetary photo shooting. Its extraordinary performance and extensive usage will give you great astrophotography experience.

The features of ATR2600C are listed below:

- IMX 571 Color CMOS Sensor
- Resolution: 6224 x 4168
- 3.76 $\mu$ m Square Pixel
- APS-C Optical Format
- 16-bit ADC
- 512 Mbyte Memory
- Precise Temperature Regulation
- G Sensitivity: 484.6mv with 1/30s
- Zero Amp-Glow
- Ultra-Low Noise: 0.79 to 2.77e- (Low Noise Mode)
- Support Low Noise Mode/ High Frame Rate Mode (6.8 FPS at all Pixel Readout 16 bit)
- SNR Max: 47.1 dB (Low Noise Mode)
- Dynamic Range: 86.8 dB (Low Noise Mode)
- -35°C below ambient under short exposure/ -42°C under long exposure time (> 1s)

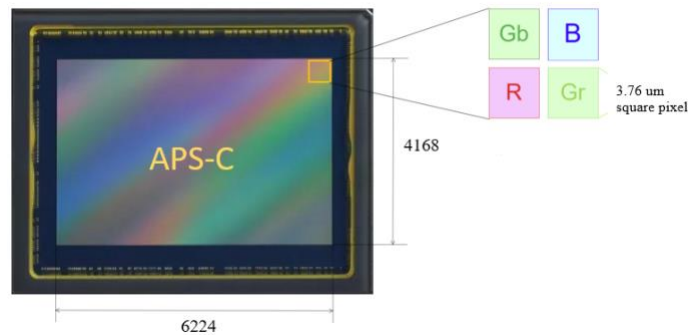

Figure 1 IMX571 Sensor and Its Pixel Structure

## 2 ATR2600C Specifications and Performance

### 2.1 Camera Specifications

Table 1 ATR2600C Technique Specifications.

Sensor	Sony IMX571 back illuminated sensor	
Diagonal	28.3 mm	
Image Resolution	26 mega pixels (6224*4168)	
Pixel Size	3.76 $\mu$ m $\times$ 3.76 $\mu$ m	
Image Area	23.4mm $\times$ 15.7mm	
Max FPS at Resolution (USB 3.0)	16bit	8bit
	6.8 FPS @ 6224*4168 28 FPS @ 3104*2084 63 FPS @ 2064*1386	13.2 FPS @ 6224*4168 37.1 FPS @ 3104*2084 110 FPS @ 2064*1386
Max FPS at Resolution (USB 2.0)	16bit	8bit
	0.6 FPS @ 6224*4168 3.6 FPS @ 3104*2084 8.5 FPS @ 2064*1386	1.2 FPS @ 6224*4168 7.0 FPS @ 3104*2084 15.7 FPS @ 2064*1386
Max FPS at Resolution (Low Noise, USB 3.0)	16bit	8bit
	3.4 FPS @ 6224*4168 ( <b>Low Noise Mode</b> is only available in <b>All Pixel Readout Mode</b> )	12.7 FPS @ 6224*4168 ( <b>Low Noise Mode</b> is only available in <b>All Pixel Readout Mode</b> )
Max FPS at Resolution (Low Noise, USB 2.0)	16bit	8bit
	0.3 FPS @ 6224*4168 ( <b>Low Noise Mode</b> is only available in <b>All Pixel Readout Mode</b> )	1.2 FPS @ 6224*4168 ( <b>Low Noise Mode</b> is only available in <b>All Pixel Readout Mode</b> )
Shutter Type	Rolling shutter	
Exposure Time	0.1ms – 3600s	
Gain	1x – 100x	
SNR	47.1 dB	
Dynamic Range	86.8 dB ( <b>Low Noise Mode</b> )	
Read Noise (Low Noise Mode)	2.77 – 0.79 e-	
QE Peak	>80%	
Full Well	51ke-	
ADC	16bit	
DDR3 Buffer	512MB (4Gb)	
Connection Port	USB3.0/USB2.0	
Camera Adaptor	M42 $\times$ 0.75mm	
Protect Windows	IR-cut filter/AR-window	
Spectral Range	380-690nm (with IR-cut filter)	
Capture/Control SDK	Windows/Linux/macOS/Android Multiple Platform SDK (Native C/C++, C#/VB.NET, Python, Java, DirectShow, Twain, etc.);	
Recording System	Still picture and movie	
Camera Dimensions	Diameter 80mm * height 107.1mm	
Camera Weight	0.577kg	
Back Focus Distance	17.5mm	
Cooling:	Two stage TEC	
Effective Cooling Temp:	-35°C below ambient under short exposure/ -42°C under long exposure (> 1s)	
Supported OS	Microsoft® Windows® XP / Vista / 7 / 8 / 10 / 11 (32 & 64 bit) OS x (Mac OS X) Linux	

## 2.2 Sony IMX571 Sensitivity

The sensor G Sensitivity of ATR2600C is 484.6mv with 1/30s. Its spectral sensitivity is shown in Figure 2.

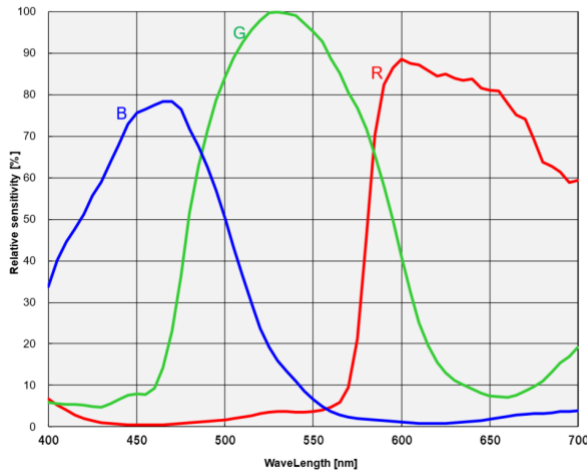

Figure 2 IMX571 Spectral Sensitivity Characteristic

## 2.3 16bit ADC and ROI

ATR2600C has built in 16bit ADC. It also has 12bit output mode for hardware binning and smaller resolution. The camera also supports hardware ROI, and the smaller the ROI size is, the higher the frame rate is.

Table 2 shows the frame rate of ATR2600C in 16/8bit mode, USB3.0 / USB2.0 data transfer interface at different resolutions:

Table 2 ATR2600C Frame Rate at Different Resolution/Data Bit/Data Transfer (USB3.0/ USB2.0)

Resolution	FPS	Bit & Interface		16bit ADC		8bit ADC	
		USB3.0	USB2.0	USB 3.0	USB 2.0		
6224 * 4168		6.8	0.6	14.2	1.2		
6224 * 4168 (Low Noise)		3.4	0.3	NA	NA		
3104*2084		28	3.6	37.1	7.0		
2064*1386		63	8.5	110	15.7		

## 2.4 DDR3 Buffer

The ATR2600C camera has a 512MB (4Gb) DDR3 buffer, which helps maintain the stability of data transmission, and effectively reduce the amp-glow caused, because image data can be temporarily buffered without being sent hastily to the receiver.

## 2.5 Binning

ATR2600C supports digital binning from 1×1 to 8×8 in either stacking or averaging method, and hardware binning from 1×1 to 3×3 in averaging method. Hardware pixel binning is much faster than software binning.

## 2.6 Conversion Gain Switch

ATR2600C support HCG and LCG mode switch, the Gain ratio is 3.01.

## 2.7 Power and Cooling System for Precise Temperature Regulation

Please remember, the Camera can be powered only by DC12V 3A power source.

The cooling system of ATR2600C is two-stage **Thermoelectric Cooling** (TEC) with controllable electric fan assisting heat dissipation.

The TEC system is controlled by PID algorithm, which allows the TEC to be precisely regulated towards the target temperature with 0.1°C deviation.

The working temperature can be regulated to specific number, and effective temperature drop can be -42°C from ambient temperature. Such efficient cooling system guarantees the stability of ultra-low noise mode and quality of the camera image.

## 2.8 Zero Amp-Glow

ATR2600C has been carefully designed and is able to achieve zero amp-glow photo shooting. Figure 3 and Figure 4 show the different cameras at 20°C and 5-minute exposure time with and without amp-glow. By comparison, the image captured by ATR2600C shows zero amp-glow.

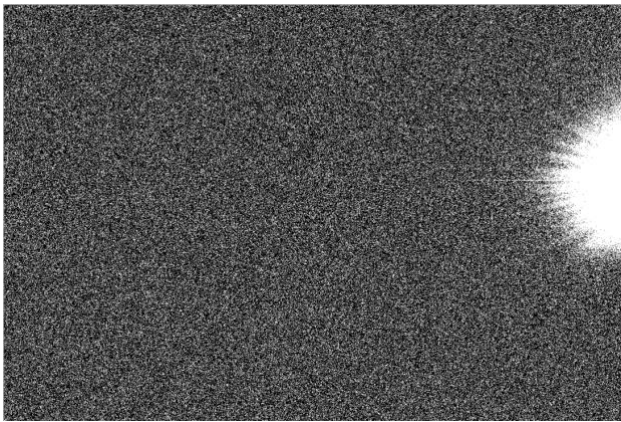

Figure 3 Amp-glow

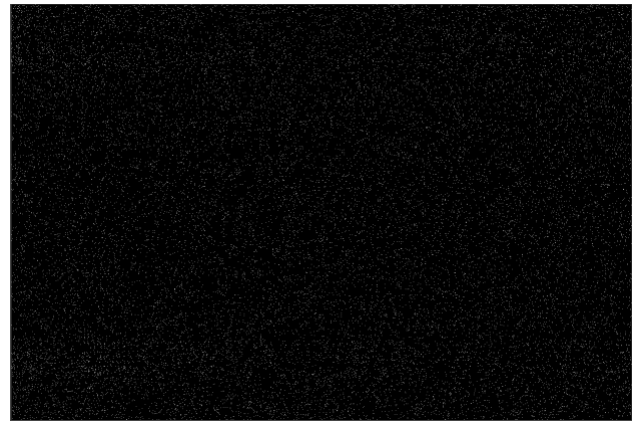

Figure 4 Zero amp-glow

## 2.9 Camera Performance Analysis

Camera performance can be evaluated with **e-/ADU**, **Read Noise**, **Full Well** and **Dynamic Range**.

**e-/ADU**: The sensors found in cameras used for vision applications have pixels that convert incoming photons into electrons. Gain on a CCD /CMOS camera represents the conversion factor from electrons (e-) into digital counts, or **Analog-Digital Units (ADUs)**. Gain is expressed as the number of electrons that get converted into a digital number, or electrons per ADU (**e-/ADU**).

**Read Noise**: **Read Noise** is created within the camera electronics during the readout process as the electrons are subjected to the analog to digital conversion, amplification and processing steps that enable an image to be produced.

**Full Well**: The electrons are held in each pixel and are converted into electrical charge which can be measured to show the amount of light that has fallen on each pixel. The maximum electrical charge possible is termed "**full well capacity**". Under the same conditions such as noise and A/D converter quality, the greater full well capacity a sensor has, the wider dynamic range the sensor has. As there is a limit to the depth to which pixels can be made, the full well capacity is often proportional to the frontal area of the light gathering element of the pixel.

**Dynamic Range**: **Dynamic range** is the ratio between the maximum output signal level and the noise floor at minimum signal amplification (noise floor which is the RMS (root mean square) noise level in a black image). The noise floor of the camera contains sensor readout noise, camera processing noise and the dark current shot noise. **Dynamic range** represents the camera's ability to display/reproduce the brightest and darkest portions of the image and how many variations in between. This is technically intra-scene dynamic range. Within one image there may be a portion that is in complete black and a portion that is completely saturated.

For the ATR series camera, the [Gain Value](#) is in xxx% mode. Here xxx is used as the x axis ([Gain Value](#)) for the description of the camera performance

$$Rel\ Gain(dB) = 20 * \log_{10}[xxx(Gain\ Value)/100]$$

$$xxx(Gain\ Value) = 100 \times 10^{(Rel\ Gain(dB)/20)}$$

Read noise is the most important reference to measure the performance of a camera. Lower read noise usually means better SNR and better quality of image.

It is impressive that ATR2600C comes with [Low Noise Mode](#), which means users could get even lower readout noise by selecting [Low Noise Mode](#) while the frame rate is reduced as sacrifice. Its significantly low read noise is: 0.79-2.77 e- ([Low Noise Mode](#)).

**All following data were acquired in SharpCap with ASCOM driver:**

*(The ASCOM Driver version for camera TEST in Low noise mode & High full well mode was relatively new)*

Camera setting used for HCG performance analysis is shown below:

- Full resolution
- RAW 16-bit mode
- Temperature: -10°C

Figure 5 shows the curves of the camera analysis data in Table 3

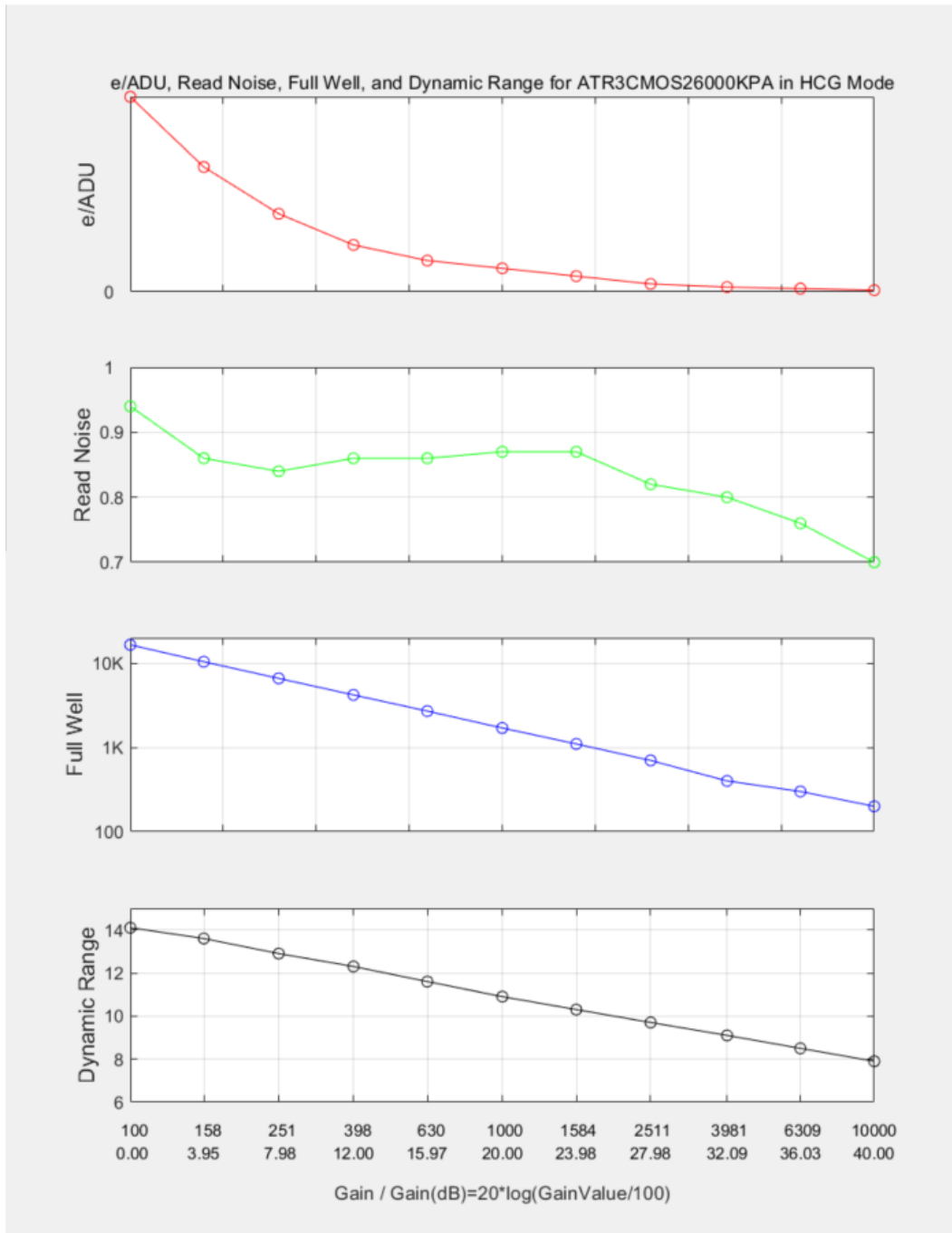

Figure 5 e-/ADU, Read Noise, Full Well and Dynamic Range for ATR2600C



The camera analysis data is shown in Table 3:

Table 3 Camera Analysis Data

Sensor Analysis Data											
Gain Value	100	158	251	398	630	1000	1584	2511	3981	6309	10000
Rel Gain (dB)	0.00	3.99	8.03	11.90	15.89	19.90	23.87	27.81	31.83	35.84	39.83
e-/ADU	0.25	0.16	0.10	0.06	0.04	0.03	0.02	0.01	0.006	0.004	0.002
Read Noise (e-)	0.94	0.86	0.84	0.86	0.86	0.87	0.87	0.82	0.80	0.76	0.70
Full Well (ke-)	16.5	10.4	6.6	4.2	2.7	1.7	1.1	0.7	0.4	0.3	0.2
Dynamic Range (stop)	14.1	13.6	12.9	12.3	11.6	10.9	10.3	9.7	9.1	8.5	7.9

Camera setting used for HCG performance analysis is shown below (Low noise mode & High full well mode) :

- Full resolution
- RAW 16-bit mode
- Temperature: -10°C

Figure 5.1 shows the curves of the camera analysis data in Table 3.1

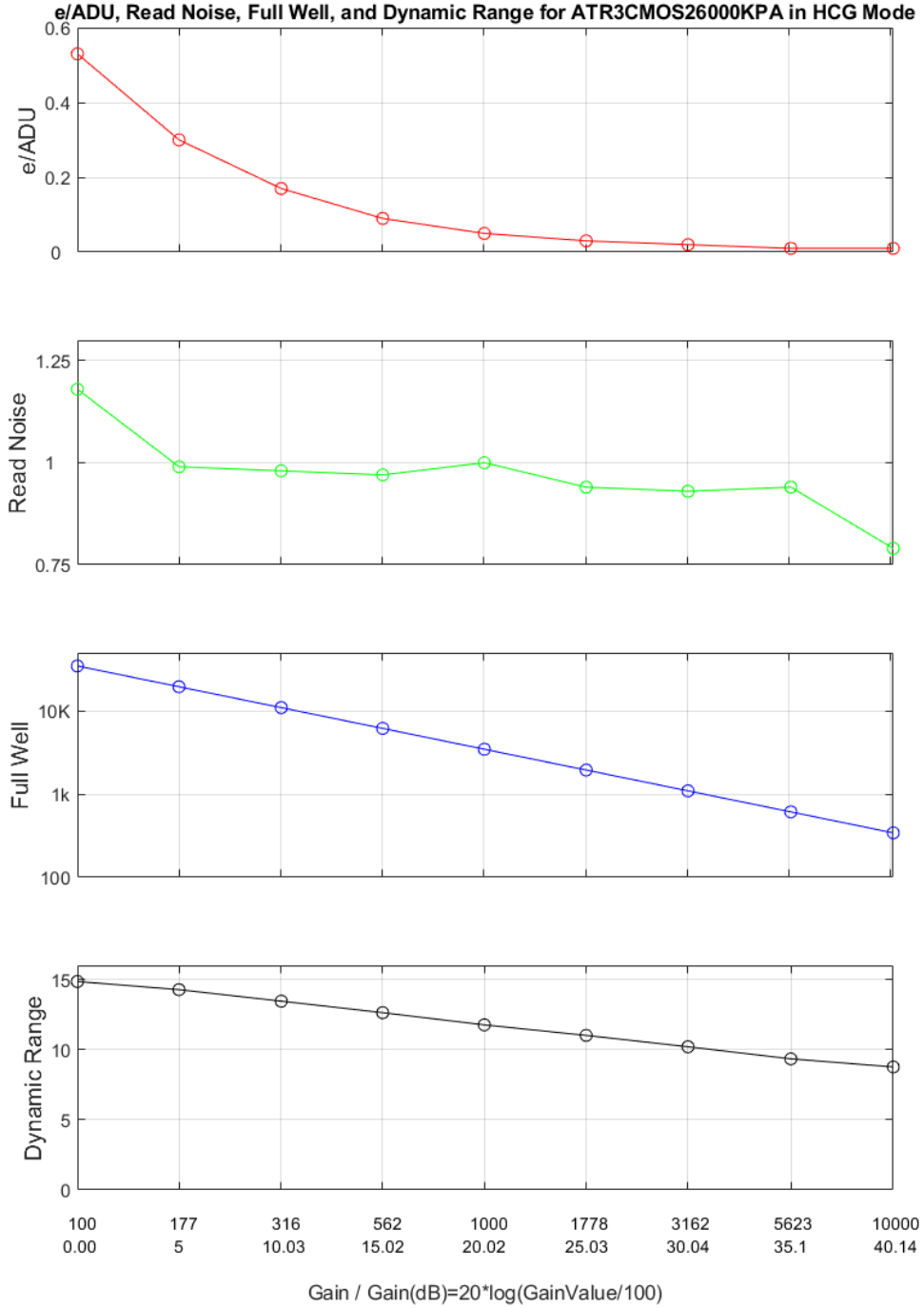

Figure 6.1 e/ADU, Read Noise, Full Well and Dynamic Range for ATR2600C

The camera analysis data is shown in Table 3.1:

Table 4.1 Camera Analysis Data

Sensor Analysis Data									
Gain Value	100	177	316	562	1000	1778	3162	5623	10000
Rel Gain (dB)	0.00	5.0	10.03	15.02	20.02	25.03	30.04	35.10	40.14
e-/ADU	0.53	0.30	0.17	0.09	0.05	0.03	0.02	0.01	0.01
Read Noise (e-)	1.18	0.99	0.98	0.97	1.00	0.94	0.93	0.94	0.79
Full Well (ke-)	34.8	19.5	11	6.2	3.5	1.9	1.1	0.6	0.3
Dynamic Range (stop)	14.85	14.27	13.45	12.63	11.76	11.01	10.20	9.34	8.76

Camera setting used for LCG performance analysis is shown below:

- Full resolution
- RAW 16-bit mode
- Temperature: -10°C

Figure 7 shows the curves of the camera analysis data in **Error! Reference source not found.**

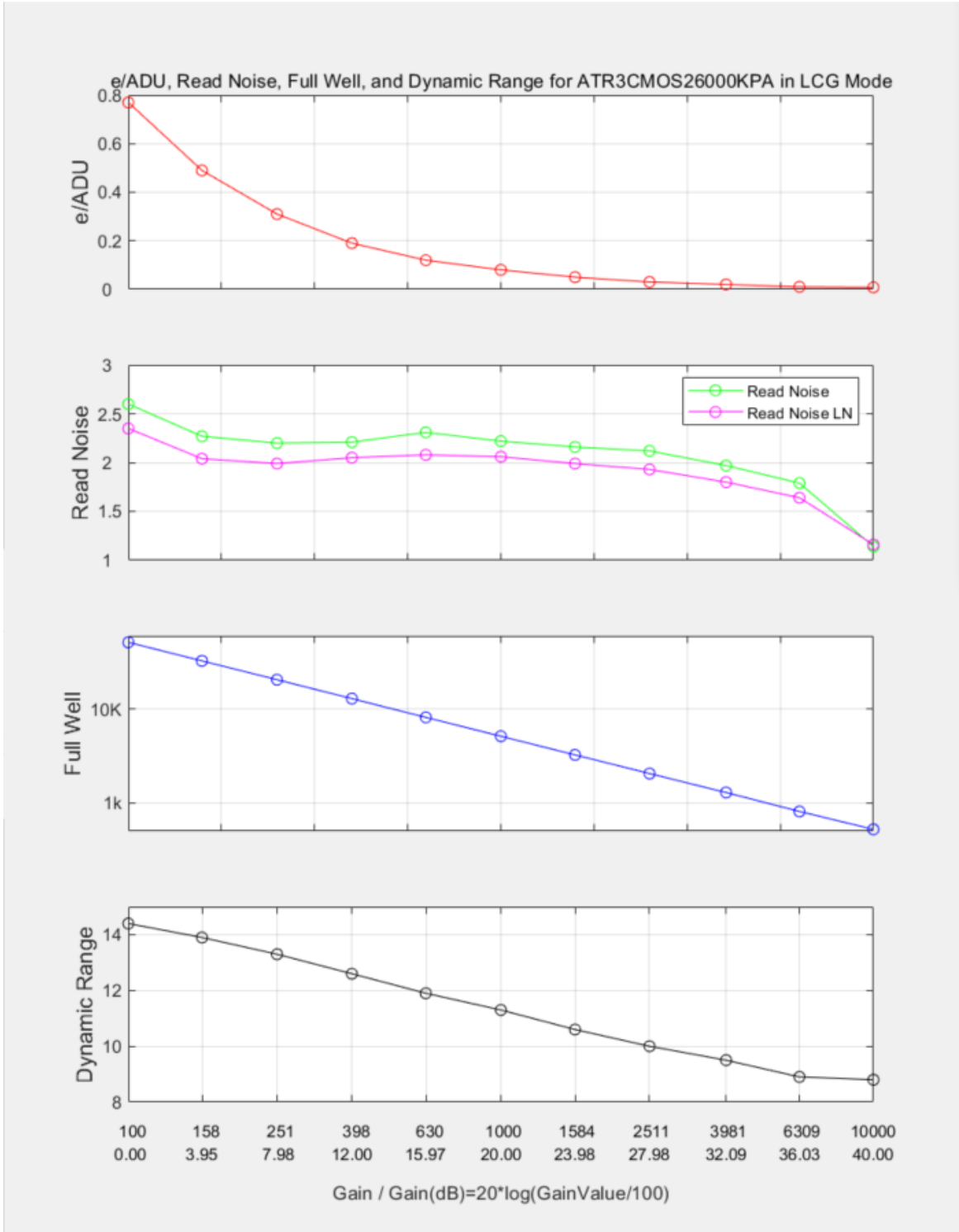

Figure 7 e-/ADU, Read Noise, Full Well and Dynamic Range for ATR2600C

The camera analysis data is shown in **Error! Reference source not found.**:

Table 5 Camera Analysis Data

Sensor Analysis Data											
Gain Value	100	158	251	398	630	1000	1584	2511	3981	6309	10000
Rel Gain (dB)	0.00	3.96	8.00	12.03	16.02	20.04	24.02	27.98	32.03	36.02	39.96
e-/ADU	0.77	0.49	0.31	0.19	0.12	0.08	0.05	0.03	0.02	0.01	0.008
Read Noise Low Noise (e-)	2.35	2.04	1.99	2.05	2.08	2.06	1.99	1.93	1.8	1.64	1.16
Read Noise (e-)	2.6	2.27	2.2	2.21	2.31	2.22	2.16	2.12	1.97	1.79	1.14
Full Well (ke-)	51.3	32.5	20.5	12.9	8.1	5.1	3.2	2.1	1.3	0.8	0.5
Dynamic Range (stop)	14.4	13.9	13.3	12.6	11.9	11.3	10.6	10.0	9.5	8.9	8.8

Camera setting used for LCG performance analysis is shown below (Low noise mode & High full well mode) :

- Full resolution
- RAW 16-bit mode
- Temperature: -10°C

Figure 7.1 shows the curves of the camera analysis data in **Error! Reference source not found..1**

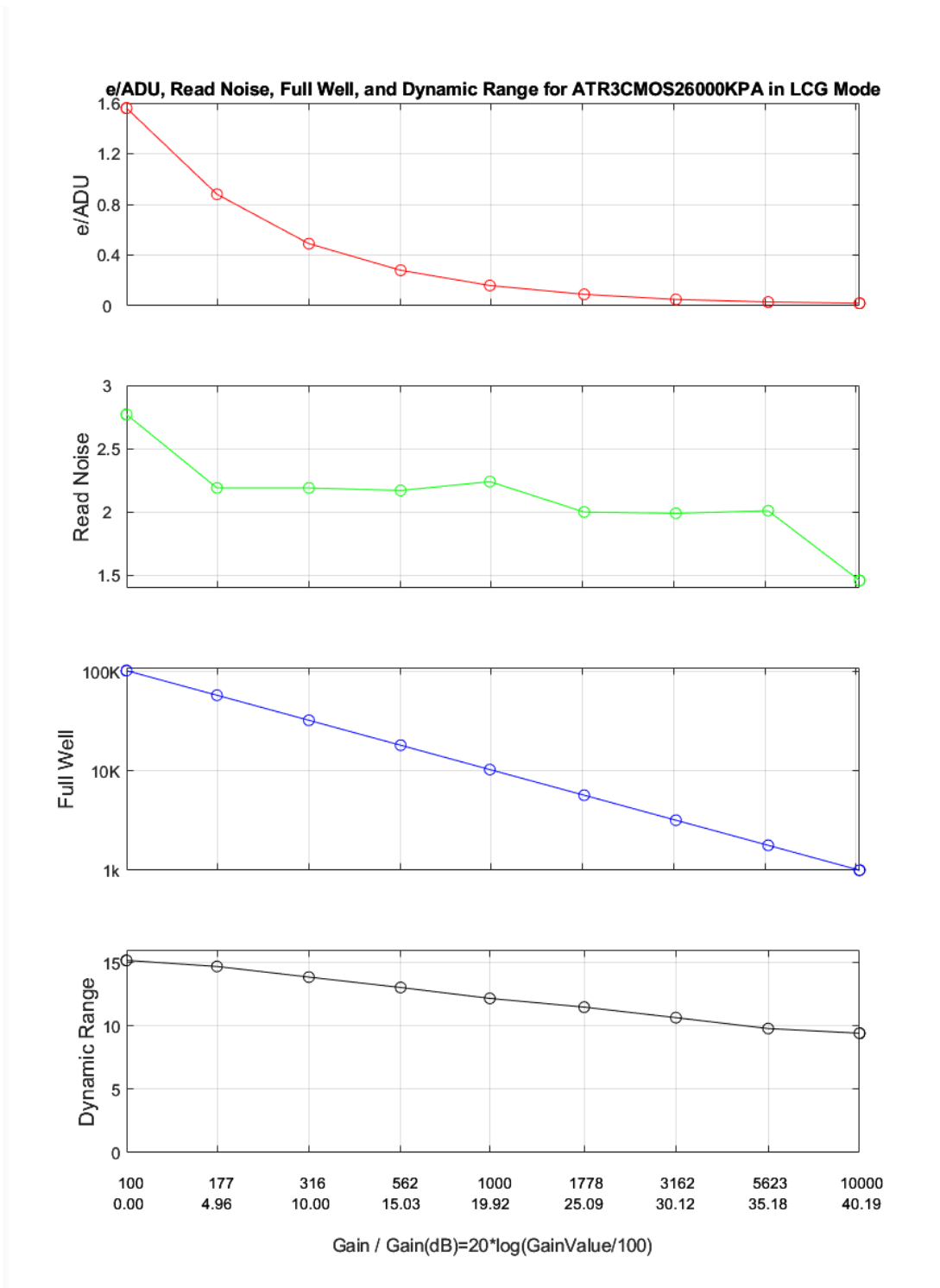

Figure 8.1 e-/ADU, Read Noise, Full Well and Dynamic Range for ATR2600C

The camera analysis data is shown in **Error! Reference source not found..1:**

Table 6.1 Camera Analysis Data

Sensor Analysis Data									
Gain Value	100	177	316	562	1000	1778	3162	5623	10000
Rel Gain (dB)	0.00	4.96	10.00	15.03	19.92	25.09	30.12	35.18	40.19
e-/ADU	1.56	0.88	0.49	0.28	0.16	0.09	0.05	0.03	0.02
Read Noise Low Noise (e-)	2.77	2.19	2.19	2.17	2.24	2.00	1.99	2.01	1.46
Full Well (ke-)	102.5	57.9	32.4	18.2	10.3	5.7	3.2	1.8	1
Dynamic Range (stop)	15.17	14.69	13.85	13.03	12.17	11.48	10.65	9.79	9.42

### 3 Product Package and Connections

#### 3.1 Packing List

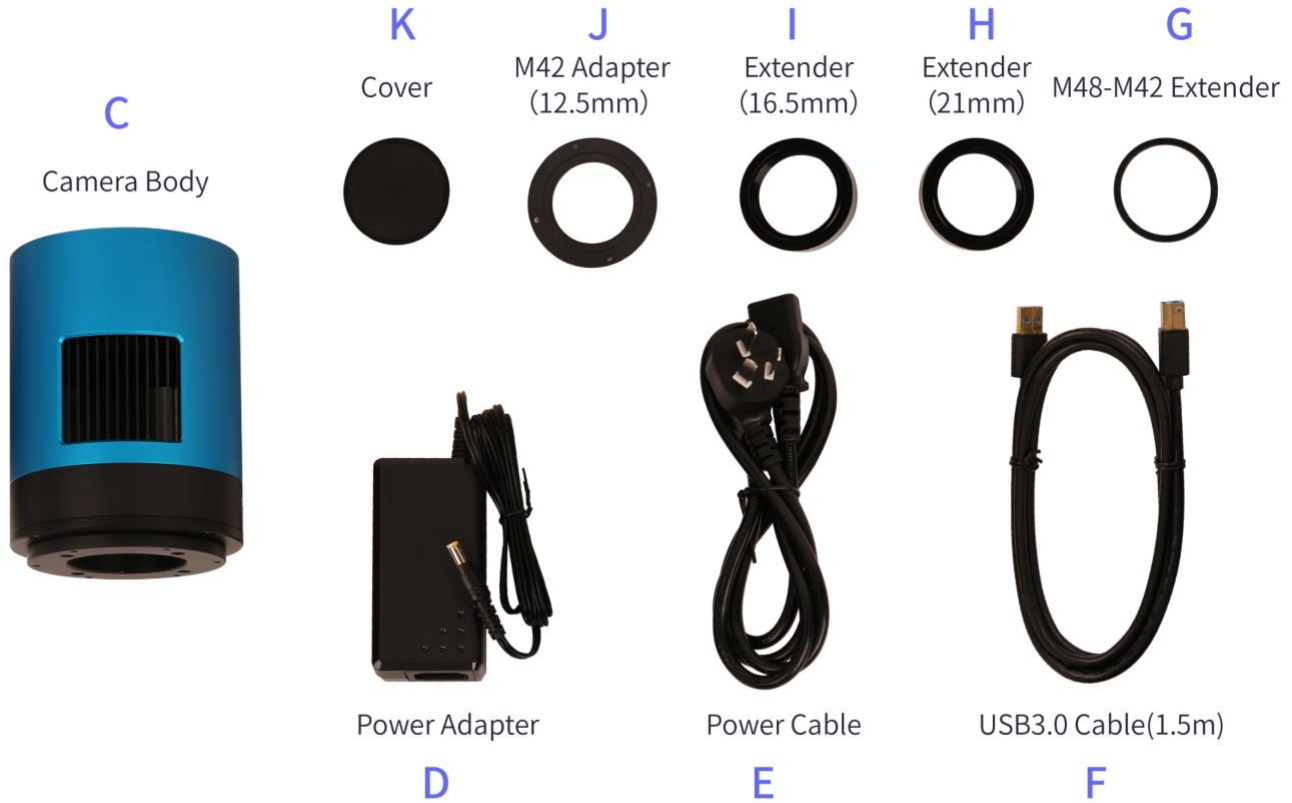

Figure 9 Packing Information of ATR2600C

Table 7 ATR2600C Packing List

Standard Package	
A	Carton L:50cm W:30cm H:30cm (20pcs, 12~17Kg/ carton, 0.045m <sup>3</sup> ), not shown in the photo
B	3-A safety equipment case: L:28cm W:23cm H:15cm (1pcs, 3.9Kg/ box); carton size: L:28.2cm W:16.7cm H:25.5cm ( <b>TBD</b> ), not shown in the photo
C	ATR series camera (M42x0.75 Mount+2" adapter)
D	Power adapter: input: AC 100~240V 50Hz/60Hz, output: DC 12V 3.3A
E	Power cable
F	High-Speed USB3.0 A male to B male gold-plated connectors cable /1.5m
G	M48-M42 extender 0mm
H	M42M-M42F extender 21mm ( <b>TBD</b> )
I	M48F - M42M extender 16.5mm ( <b>TBD</b> )
J	M42M adapter 12.5mm
K	Cover



### 3.2 Camera Dimension and Its Mount

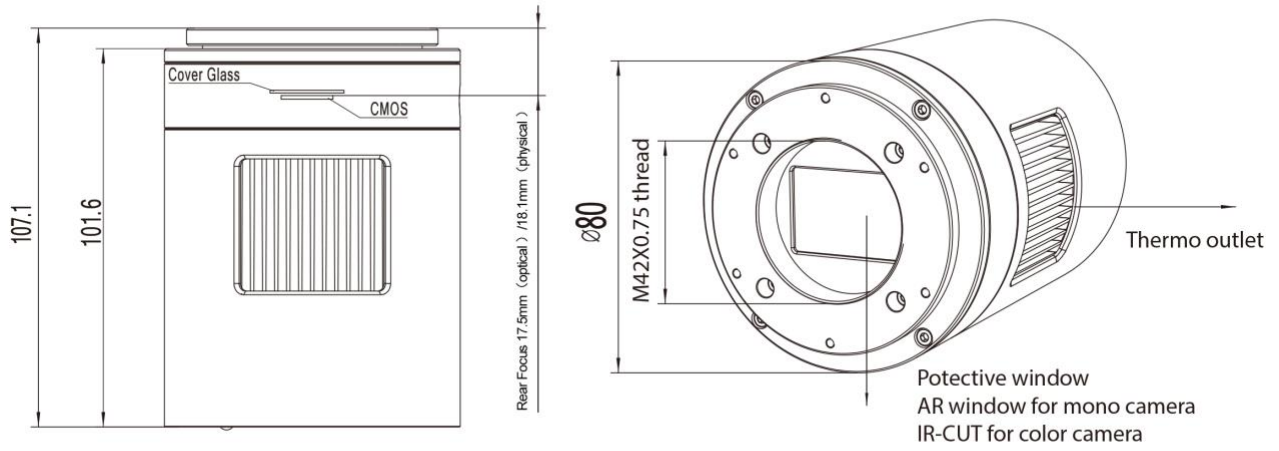

Figure 10 Dimension and Mount of ATR2600C

Table 8 Dimension and Mount of ATR2600C

Item	Specification
Diameter	$\varnothing 80$ mm
Height	107.1mm
Mount	M42Fx0.75mm

### 3.3 Camera Outline and Interface

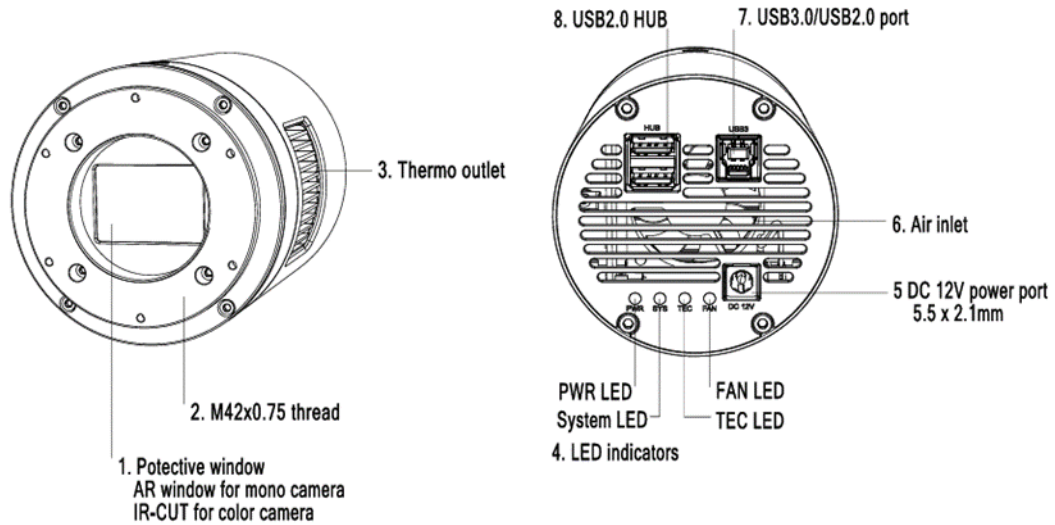

Figure 11 Camera Outline and Interface

Table 9 Camera Outline and Interface List

Item	Specification
1	Protective window, AR window for mono camera, IR-cut filter for color camera
2	M42F × 0.75 thread
3	Thermal outlet or radiator
4	LED indicators: 1) Power LED. 2) System LED. 3)TEC LED. 4)Fan LED
5	DC 12V 3A power port, 5.5 × 2.1mm
6	Air inlet
7	USB 3.0/ USB 2.0 port
8	USB 2.0 HUB

### 3.4 Camera Mechanical Connection with Adapter

ATR2600C can be connected to a telescope with proper adapter, or the camera lens. The most common adapters are already included in the package, but we also provide some specific adaptors based on the requirement.

The female flange to the sensor is 17.5mm. ATR2600C comes with M42x0.75 mount and can connect to telescope with the M42x0.75 thread in a direct way.

ATR2600C can also connect to the telescope who use 1.25" or 2" eyepieces by M42M-1.25" or M42M-2" adapter. Figure 12 shows the connection of the camera and the adapter. After the adapter is screwed to the camera, the camera can insert into the

telescope’s eyepiece tube. Table 10 list the details of the camera and adapter parameters.

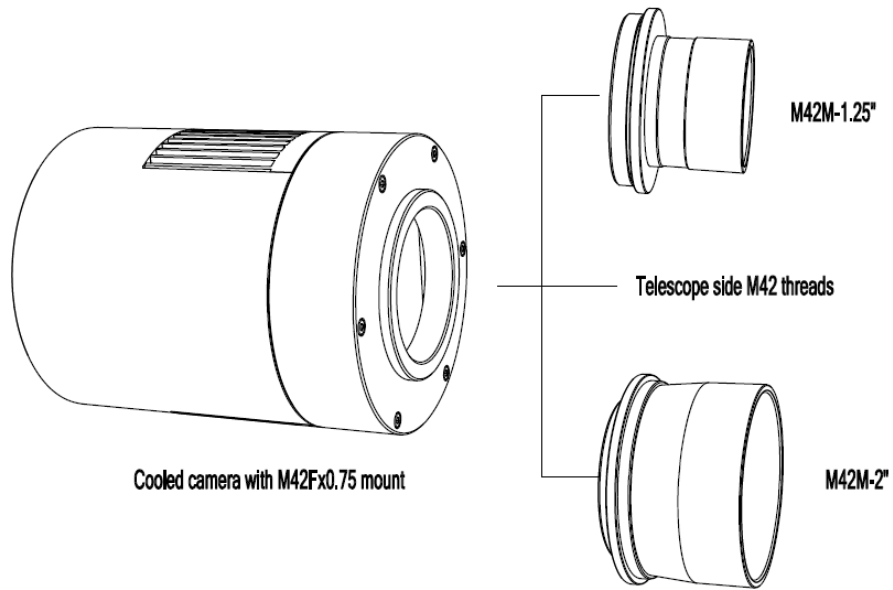

Figure 12 The Connection of the ATR Camera and Adapter

Table 10 Camera and Its Adapter Connections

Item	Specification
Back Focal Distance	17.50mm
M42M-1.25" Adapter	M48M-1.25" adapter for 1.25" telescope
M42M-2" Adapter	M42M-2" adapter for 2" telescope

### 3.5 Camera Mechanical Connection with Lens

Figure 13 shows the connections of the ATR camera and the lens. Table 11 list the connection’s parameters.

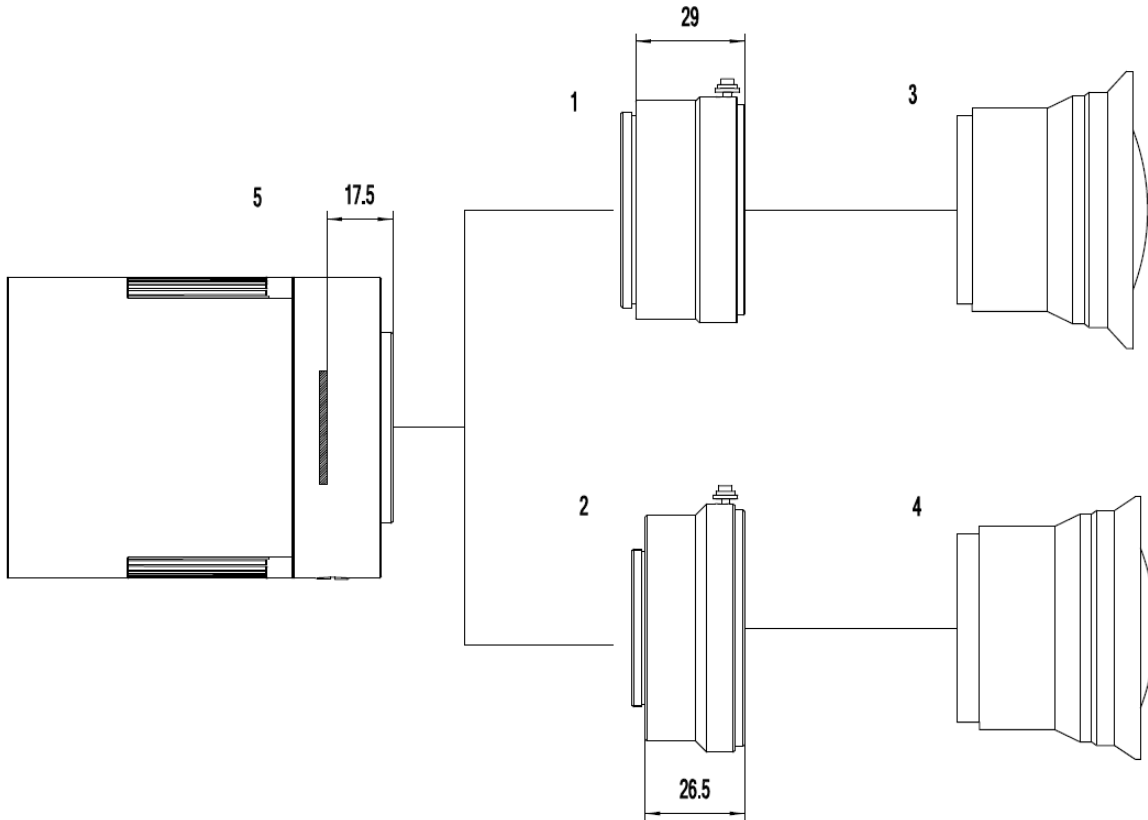

Figure 13 Nikon F/Canon EF Lens with ATR Camera

Table 11 Camera and Lens Connection

Item	Specification
1	Nikon F-M42 adapter ( <b>TBD</b> )
2	EOS EF-M42 adapter
3	Nikon F-mount lens
4	Canon EF-mount lens
5	ATR camera with M42Fx0.75 mount

### 3.6 Camera Electric Connection with Accessories

On the back side of ATR2600C, there are 3 connection ports: DC 12V/3A power port, USB3.0/ USB2.0 port and USB-HUB.

Due to the significantly larger power consumption of IMX571, ATR2600C (including the cooling system) is now booted up only by 12V/3A power supply. USB3.0 no longer works as a power source but only as a data communication method. The USB-HUB provides connection with other devices, which allows user to avoid the mess of cable management. Once another device is connected through the USB-HUB, it will be connected to PC device through the USB3.0/USB2.0 port.

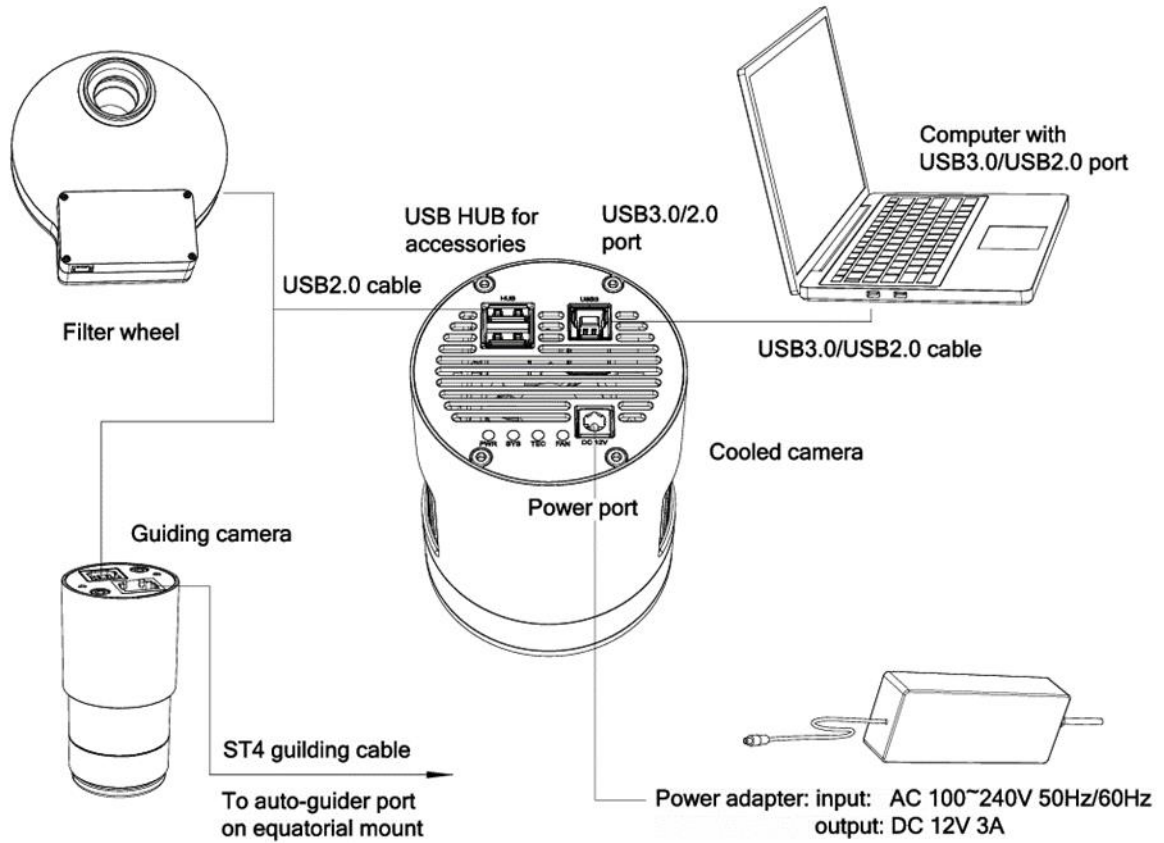

Figure 14 Camera Electric Connection

Table 12 Camera Electric Connection Details

Item	Specification
USB3.0/USB2.0 Port	To computer with USB3.0/USB2.0 cable
USB HUB for Accessories	To filter wheel with USB2.0 cable
	To guiding camera with USB 2.0 cable
Power Port	DC12V/3A

## 4 ATR2600C and Its Software

### 4.1 Application Installation

For software, customers are welcomed to go to our software website: <https://toupTek-astro.com/downloads/>, to download the latest ToupSky. The ATR can also be used with ASCOM, DirectShow SDK. If the third-party software is compatible with these SDK, customers can also download the software driver from our website and install the drivers into the third-party software.

ToupSky is ToupTek astronomy camera's Windows application. ToupSky is a professional software integrated with camera control, image capture & process, image browse, and analysis functions. ToupSky is born with the following features:

Windows:

- x86: XP SP3 or above; CPU supports SSE2 instruction set or above
- x64: Win7 or above

Features

- Full control of the camera
- Trigger mode and video mode support (raw format or RGB format)
- Automatic capture and quick record function
- Multi-language support
- Hardware ROI and digital binning function
- Extensive image processing functions, like image stitching, live stacking, flat field correction, dark field correction, etc.

Supported Camera:

- All ToupTek astronomy cameras

#### 4.1.1 User-friendly UI Design

- Well-arranged menus and toolbars ensure quick operating;
- The unique design of 3 sidebars -- [Camera](#), [Folders](#), [Undo/Redo](#) are orderly classified;
- Convenient operating method (Double click or right-click context menu) as much as possible;
- Detailed help manual;

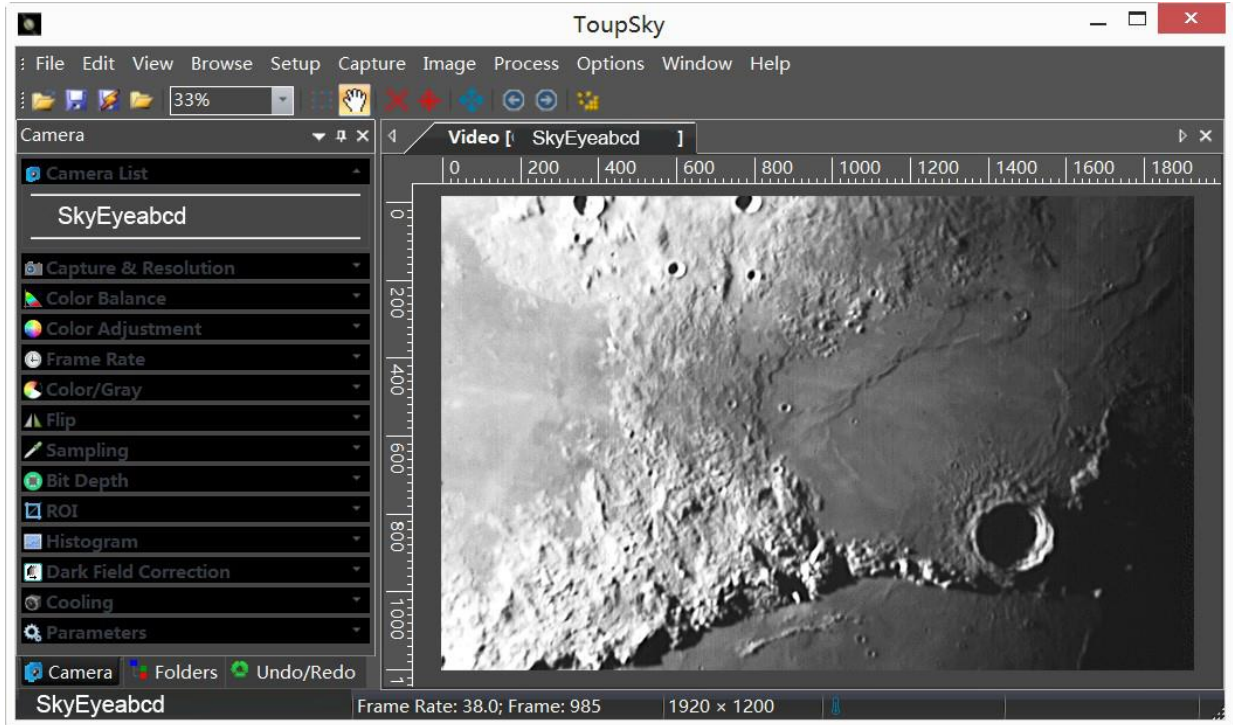

Figure 15 ToupSky and Its Video Window

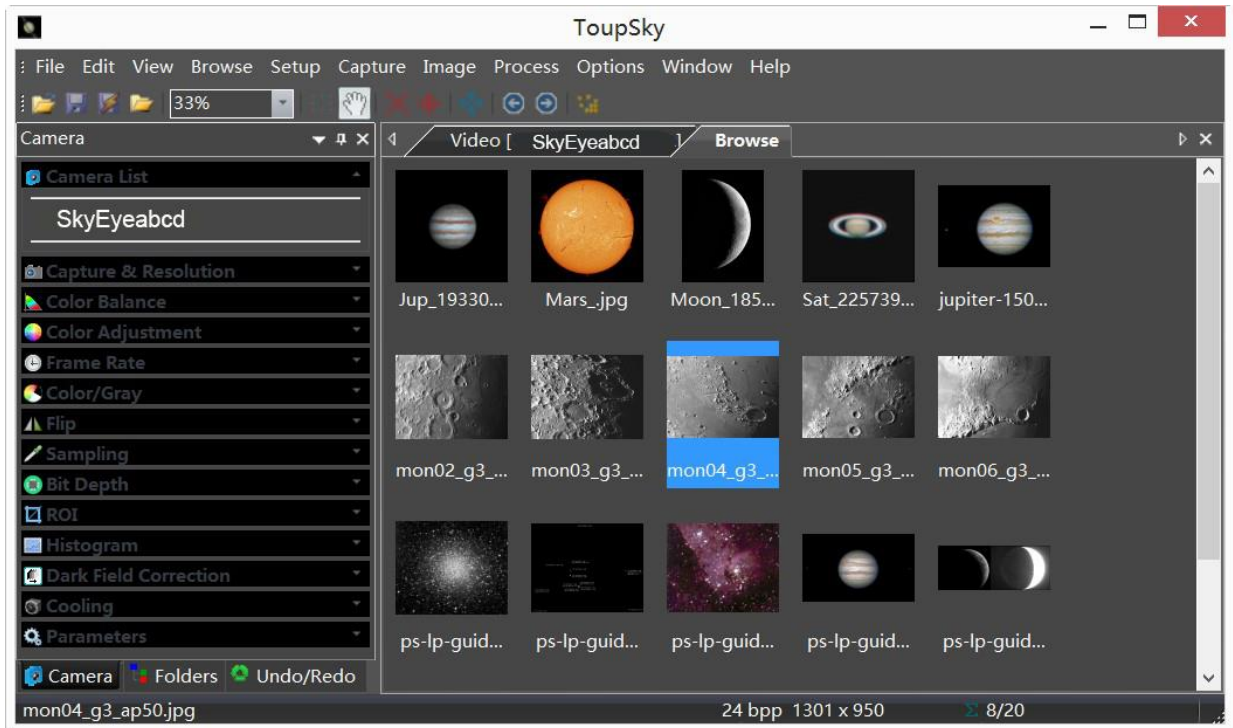

Figure 16 ToupSky and Its Browse Window

#### 4.1.2 Professional Camera Control Panel

Capture & Resolution	Set the live and snap resolution and snap the image or record video;
Exposure & Gain	Auto exposure (exposure target preset) and manual exposure (exposure time can be inputted manually); Up to 5 times gain;
Color Balance	Advanced single-click intelligent white balance setting, temperature and tint can be manually adjusted;

Color Adjustment	Hue, saturation, brightness, contrast, gamma initialization adjustment;
Frame Rate	Adjustment of frame rate available for different computer configurations;
Flip	Check the “horizontal” or “vertical” option to correct the sample direction;
Sampling	Bin mode can obtain low noise video stream; Skip mode obtains sharper and smoother video stream. Support video stream histogram extension, Negative and positive switching, Gray calibration, Clarity factor for focusing etc.
Bit Depth	Switch between 8 bits and 16 bits. 8 bits is the basic Windows image format. 16 bits will have higher image quality but moderate FPS.
ROI	ROI, Region of interest. This function can set the ROI on the video window. When the ROI group was expanded, a dotted rectangle with "Handles" will appear around the video window that will let you alter the ROI. Use mouse button to adjust the ROI size. If ROI is ok, click Apply will set the video to ROI size, Defaults will return to the original size.
Dark Field Correction	To Enable the Dark Field Correction, one should capture the dark field image first. After the images are captured, the Enable button will be clickable. Checking the Enable button will enable the Dark Field correction. Unchecking it will disable the Dark Field Correction.
Cooling	Set the TE-Cooling target temperature and set the fan On/Off;
Parameters	Load, save, overwrite, import, export self-defined parameters of camera control panel (including calibration information, exposure and color setting information);

**4.1.3 Practical Functions with Good Results**

Video functions	Various professional functions: Video broadcast; Time lapse capture; Video record; Video stream grid; Image stitch; Video scale bar, date etc.
Image Processing and Enhancement	Control and adjust image by denoise, sharpen, color toning deinterlace, all kinds of filtering algorithm and mathematical morphology algorithm, range, binary, pseudo color, surface plot and line profile ital..
Image Stacking	Image stacking adopts advanced image matching technology. With the recorded video, regardless of shifting, rotation, scaling, the high-fidelity image can be stacked to decrease the image noise.

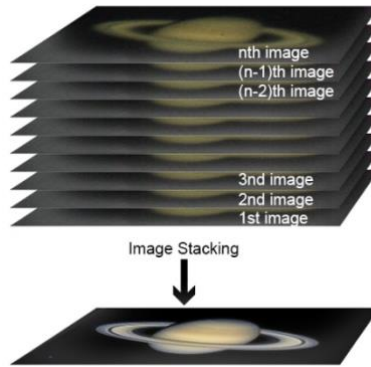

Figure 17 Image Stacking

**4.1.4 Powerful Compatibility**

Video Interface	Support Twain, DirectShow, SDK Package (Native C++、C#/VB.NET)
Operating System	Compatible with Microsoft® Windows® XP / Vista / 7 / 8 / 10 / 11 (32 & 64 bit), Mac OSX, Linux
Language Support	Unlimited language support, currently available in Simplified Chinese, Traditional Chinese, English, Russian, German, French, Polish and Turkish

**4.1.5 Hardware Requirement**

PC Requirements	CPU: Intel Core 2 2.8GHz or higher
	Memory:2GB or more
	USB port: USB3.0/USB2.0 port
	Display: 17” or larger
	CD-ROM

**4.2 ATR2600C and Dshow**

DshowAstro is an interface driver providing Dshow standard support for ToupTek USB astronomy camera

Supported OS: Windows:

- x86: XP SP3 or above; CPU supports SSE2 instruction set or above



- x64: Win7 or above

Supported Camera:

- All Touptek astronomy cameras

## 4.3 ATR2600C and the 3<sup>rd</sup> Party Software

### 4.3.1 Support Software

No.	Software	Version	WDM	ASCOM	Native
1	PHD Guiding	2.3.0(2014)	√	√	√
2	Nebulosity	3.2.2(2014)	√	×	/
3	MaxIm DL	5.23(2013)	√	×	/
4	SharpCap	2.1(2014)	√	×	/
5	MetaGuide	5.2.0(2014)	√	/	/
6	FireCapture	2.4.05(2014)	√	/	/
7	Astroart	5.0(2014)	√	×	/

### 4.3.2 N.I.N.A

Powerful open source astronomy equipment management system for deep sky photo shooting, free.

### 4.3.3 INDI

A popular third-party driver software for astronomy devices, often used on Linux and MacOS.

### 4.3.4 ASCOM Platform

All AstroCam telescope camera drivers request to install ASCOM platform, free.

<http://www.ascom-standards.org/index.htm>

You can download the ASCOM package from : <http://ascom-standards.org/Downloads/Index.htm>

### 4.3.5 PHD Guiding

A popular free guide software: <http://openphdguiding.org/>

Touptek's telescope camera support Native/ASCOM/WDM driver to run the video.

### 4.3.6 Nebulosity

A popular cooled camera control/image process software directly supported via ASCOM.

### 4.3.7 MetaGuide

Autoguiding software with novel method to avoid the atmospheric agitation. The latest version support GCMOS01200KPB and the guide port: <http://www.astrogeeks.com/Bliss/MetaGuide/>

### 4.3.8 MAXIMDL

Famous full functional CCD Control/Image Process software. Popular used in US.

### 4.3.9 AstroArt

Famous full functional CCD Control/Image Process software. Popular used in Europe.

### 4.3.10 FireCapture

Great free planetary capture software. Support part of AstroCam series telescope camera.

### 4.3.11 SharpCap

A nice free planetary capture software support WDM cameras includes AstroCam series telescope camera.

### 4.3.12 Registax

A popular free planetary stacking and processing software.

### 4.3.13 AstroStack

A planetary stacking and process software.

#### **4.3.14 DeepSky Stacker**

A free deep sky image stack and process software.

## **5 Service**

For software upgrades, please refer to “Download” on our official website: <https://touptek-astro.com/>

For customers who purchase the cameras from local dealer, please contact your dealer for more inquiry.

For technical support, please contact e-mail address: [astro@touptek.com](mailto:astro@touptek.com).