

ATR585M User Manual

Version 1.0

Nov 2024



All materials related to this publication are subject to change without notice and its copyright totally belongs to ToupTek Photonics.

Please download the latest version from touptek-astro.com.

Contents

ATR585M User Manual	1
1 Description and Features	1
2 ATR585M Specifications and Performance	1
2.1 Camera Specifications	1
2.2 Sony IMX585 Sensitivity	2
2.3 12bit ADC and ROI	2
2.4 DDR3 Buffer.....	2
2.5 Binning	3
2.6 Conversion Gain Switch.....	3
2.7 Power and Cooling System for Precise Temperature Regulation.....	3
2.8 Zero Amp-Glow.....	3
2.9 Camera Performance Analysis.....	3
3 Product Package and Connections	11
3.1 Packing List	11
3.2 Camera Dimension and Its Mount.....	12
3.3 Camera Outline and Interface	13
3.4 Camera Mechanical Connection with Adapter	13
3.5 Camera Mechanical Connection with Lens.....	14
3.6 Camera Electric Connection with Accessories	15
4 ATR585M and Its Software	17
4.1 Application Installation	17
4.1.1 <i>User-friendly UI Design</i>	17
4.1.2 <i>Professional Camera Control Panel</i>	18
4.1.3 <i>Practical Functions with Good Results</i>	19
4.1.4 <i>Powerful Compatibility</i>	19
4.1.5 <i>Hardware Requirement</i>	19
4.2 ATR585M and Dshow	20
4.3 ATR585M and the 3 rd Party Software.....	20
4.3.1 <i>Support Software</i>	20
4.3.2 <i>N.I.N.A</i>	20
4.3.3 <i>INDI</i>	20
4.3.4 <i>ASCOM Platform</i>	20
4.3.5 <i>PHD Guiding</i>	20
4.3.6 <i>Nebulosity</i>	20
4.3.7 <i>MetaGuide</i>	20
4.3.8 <i>MAXIMDL</i>	20
4.3.9 <i>AstroArt</i>	21
4.3.10 <i>FireCapture</i>	21
4.3.11 <i>SharpCAP</i>	21
4.3.12 <i>Registax</i>	21
4.3.13 <i>AstroStack</i>	21
4.3.14 <i>DeepSky Stacker</i>	21
5 Service	22

1 Description and Features

The ATR585M(ATR3CMOS08300KMA) camera is designed specifically for astrophotography. It is mainly used for deep sky photo shooting, since the camera has cooled CMOS sensor, ultra-low readout noise and zero amp-glow. It can be also used for planetary photo shooting. Its extraordinary performance and extensive usage will give you great astrophotography experience.

The features of ATR585M are listed below:

- IMX 585 mono CMOS Sensor
- Resolution: 3840 x 2160
- 2.9 μ m Square Pixel
- 1/1.2-inch Optical Format
- 12-bit ADC
- 512 Mbyte Memory
- Precise Temperature Regulation
- G Sensitivity: 9560mv with 1/30s
- Zero Amp-Glow
- Low Noise: 0.50 to 3.04e-
- Support High Frame Rate Mode (24 FPS at all Pixel Readout 12 bit)
- SNR Max: 45 dB
- Dynamic Range: 88.6 dB (HDR)
- -35°C below ambient under short exposure / -45°C under long exposure time (> 1s)

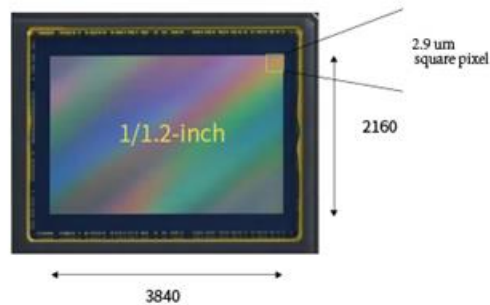

Figure 1 IMX585 is an advanced image sensor featuring a sophisticated pixel architecture.

2 ATR585M Specifications and Performance

2.1 Camera Specifications

Table 1 ATR585M Technique Specifications.

Sensor	Sony IMX585 back illuminated sensor	
Diagonal	12.85 mm	
Image Resolution	8.3 mega pixels (3840*2160)	
Pixel Size	2.9 μ m \times 2.9 μ m	
Image Area	11.2mm \times 6.3mm	
Max FPS at Resolution (USB 3.0)	12bit	8bit
	24 FPS @ 3840*2160 70 FPS @ 1920*1080	47 FPS @ 3840*2160 70 FPS @ 1920*1080
Max FPS at Resolution (USB 2.0)	14bit	8bit
	2.5 FPS @ 3840*2160 7.3 FPS @ 1920*1080	5.6 FPS @ 3840*2160 7.9 FPS @ 1920*1080
Shutter Type	Rolling shutter	
Exposure Time	0.1ms – 3600s	
Gain	1x – 100x	
SNR	45 dB	
Dynamic Range	88.6 dB (HDR Mode)	
Read Noise	3.04– 0.50 e-	
QE Peak	>91%	
Full Well	38.9ke-	
ADC	12bit (16bit @ HDR)	
DDR3 Buffer	512MB (4Gb)	
Connection Port	USB3.0/USB2.0	
Camera Adaptor	M42 \times 0.75mm	
Protect Windows	IR-cut filter/AR-window	
Spectral Range	380-1100nm (with AR-window)	
Capture/Control SDK	Windows/Linux/macOS/Android Multiple Platform SDK (Native C/C++, C#/VB.NET, Python, Java, DirectShow, Twain, etc.);	
Recording System	Still picture and movie	
Camera Dimensions	Diameter 80mm * height 107.1mm	
Camera Weight	0.577kg	
Back Focus Distance	17.5mm	
Cooling:	Two stage TEC	
Effective Cooling Temp:	-35°C below ambient under short exposure/ -45°C under long exposure(> 1s)	
Supported OS	Microsoft® Windows® XP / Vista / 7 / 8 / 10 / 11(32 & 64 bit) OS x (Mac OS X) Linux	

2.2 Sony IMX585 Sensitivity

The sensor G Sensitivity of ATR585M is 9560mv with 1/30s. Its spectral sensitivity is shown in Figure .

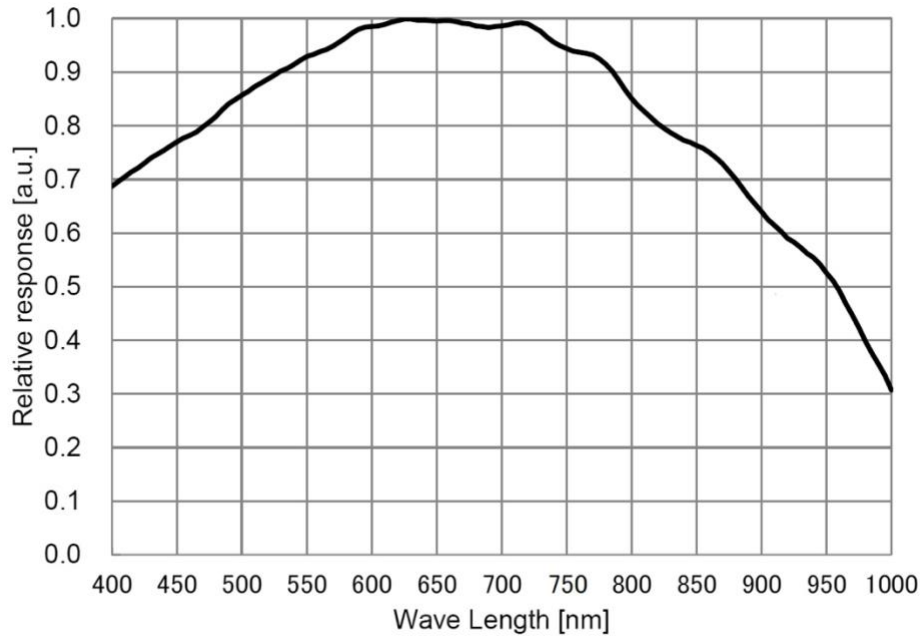

Figure 2 IMX585 Spectral Sensitivity Characteristic

2.3 12bit ADC and ROI

ATR585M has built in 12bit ADC. It also has 12bit output mode for hardware binning and smaller resolution. The camera also supports hardware ROI, and the smaller the ROI size is, the higher the frame rate is.

Table 2 shows the frame rate of ATR585M in 12/8bit mode, USB3.0 / USB2.0 data transfer interface at different resolutions: When HDR mode is enabled, frame rate is reduced to half.

Table 2 ATR585M Frame Rate at Different Resolution/Data Bit/Data Transfer (USB3.0/ USB2.0)

Resolution	FPS	Bit & Interface		12bit ADC		8bit ADC	
		USB3.0	USB2.0	USB 3.0	USB 2.0		
3840 * 2160		24	2.5	47	5.6		
1920*1080		70	7.3	70	7.9		

2.4 DDR3 Buffer

The ATR585M camera has a 512MB (4Gb) DDR3 buffer, which helps maintain the stability of data transmission, and effectively reduce the amp-glow caused, because image data can be temporarily buffered without being sent hastily to the receiver.

2.5 Binning

ATR585M supports digital binning from 1×1 to 8×8 in either stacking or averaging method, and hardware binning from 1×1 to 2×2 in averaging method. Hardware pixel binning is much faster than software binning.

2.6 Conversion Gain Switch

ATR585M support [HCG](#)、[LCG](#) and [HDR](#) mode switch.

2.7 Power and Cooling System for Precise Temperature Regulation

Please remember, the Camera can be powered only by DC12V 3A power source.

The cooling system of ATR585M is two-stage [Thermoelectric Cooling](#) (TEC) with controllable electric fan assisting heat dissipation.

The TEC system is controlled by PID algorithm, which allows the TEC to be precisely regulated towards the target temperature with 0.1°C deviation.

The working temperature can be regulated to specific number, and effective temperature drop can be -45°C from ambient temperature. Such efficient cooling system guarantees quality of the camera image.

2.8 Zero Amp-Glow

ATR585M has been carefully designed and is able to achieve zero amp-glow photo shooting. Figure 3 and Figure 4 show the different cameras at 20°C and 5-minute exposure time with and without amp-glow. By comparison, the image captured by ATR585M shows zero amp-glow.

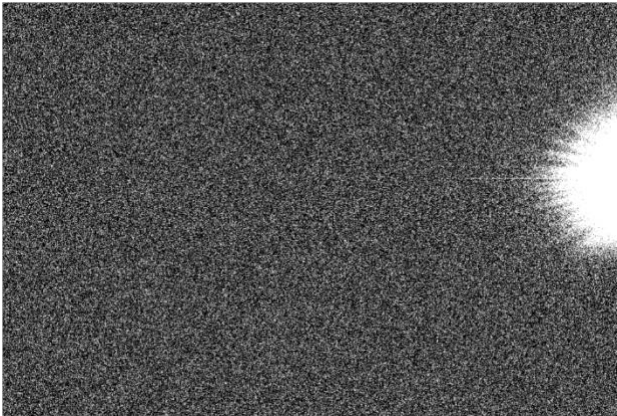

Figure 3 Amp-glow



Figure 4 Zero amp-glow

2.9 Camera Performance Analysis

Camera performance can be evaluated with [e-/ADU](#), [Read Noise](#), [Full Well](#) and [Dynamic Range](#).

e-/ADU: The sensors found in cameras used for vision applications have pixels that convert incoming photons into electrons. Gain on a CCD /CMOS camera represents the conversion factor from electrons (e-) into digital counts, or [Analog-Digital Units \(ADUs\)](#). Gain is expressed as the number of electrons that get converted into a digital number, or electrons per ADU ([e-/ADU](#)).

Read Noise: [Read Noise](#) is created within the camera electronics during the readout process as the electrons are subjected to the analog to digital conversion, amplification and processing steps that enable an image to be produced. [Read Noise](#) is the most important reference to measure the performance of a camera. Lower read noise usually means better SNR and better quality of image.

Full Well: The electrons are held in each pixel and are converted into electrical charge which can be measured to show the amount of light that has fallen on each pixel. The maximum electrical charge possible is termed "[full well capacity](#)". Under

the same conditions such as noise and A/D converter quality, the greater full well capacity a sensor has, the wider dynamic range the sensor has. As there is a limit to the depth to which pixels can be made, the full well capacity is often proportional to the frontal area of the light gathering element of the pixel.

Dynamic Range: **Dynamic Range** is the ratio between the maximum output signal level and the noise floor at minimum signal amplification (noise floor which is the RMS (root mean square) noise level in a black image). The noise floor of the camera contains sensor readout noise, camera processing noise and the dark current shot noise. **Dynamic range** represents the camera's ability to display/reproduce the brightest and darkest portions of the image and how many variations in between. This is technically intra-scene dynamic range. Within one image there may be a portion that is in complete black and a portion that is completely saturated.

For the ATR series camera, the **Gain Value** is in xxx% mode. Here xxx is used as the x axis (**Gain Value**) for the description of the camera performance

$$Rel\ Gain(dB) = 20 * \log_{10}[xxx(Gain\ Value)/100]$$

$$xxx(Gain\ Value) = 100 \times 10^{(Rel\ Gain(dB)/20)}$$

All following data were acquired in SharpCap with ASCOM driver:

Camera setting used for HCG performance analysis is shown below:

- Full resolution
- RAW 12-bit mode
- Temperature: -10°C

Figure shows the curves of the camera analysis data in Table 3

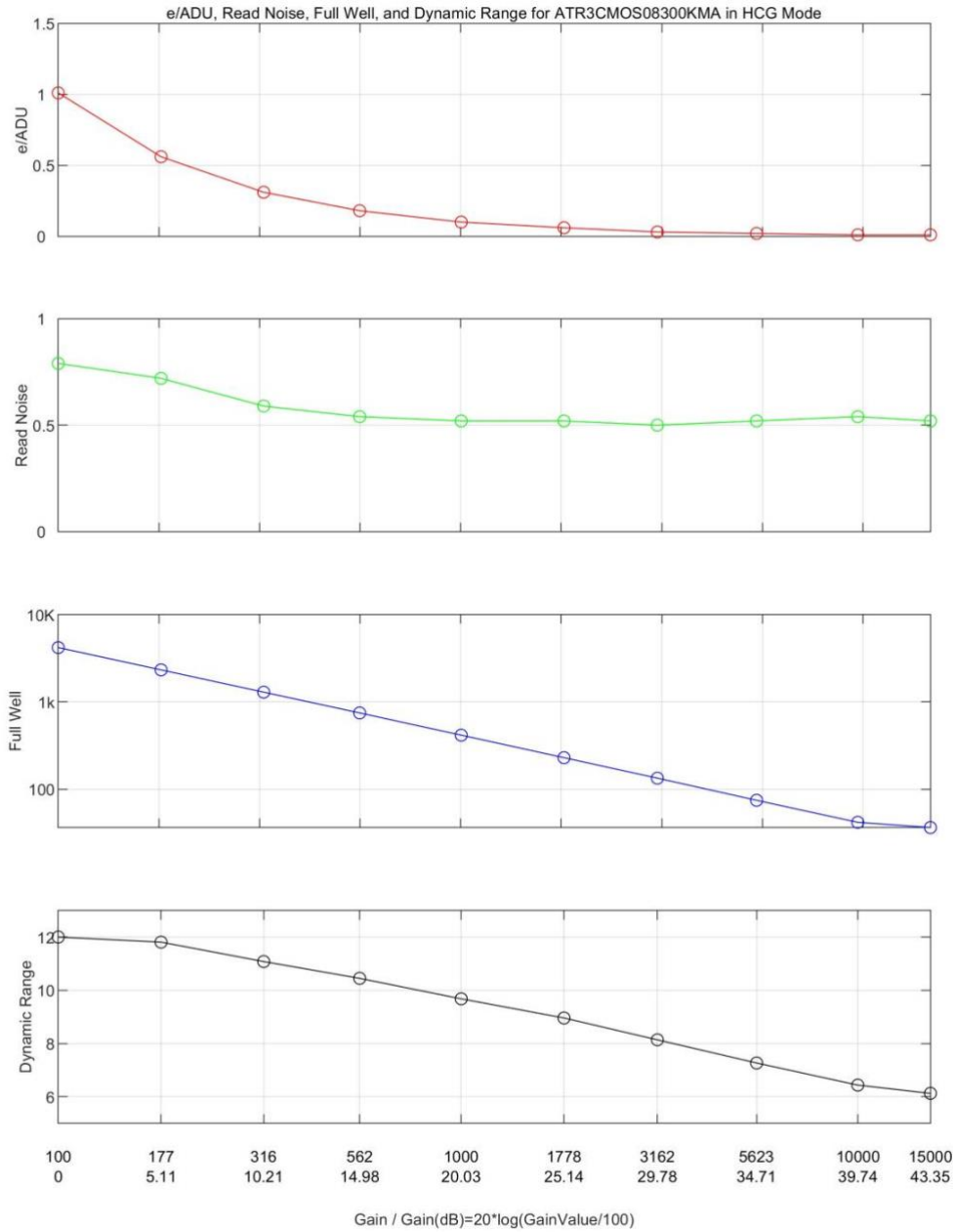

Figure 5 e-/ADU, Read Noise, Full Well and Dynamic Range for ATR585M

The camera analysis data is shown in Table 3:

Table 3 Camera Analysis Data

Sensor Analysis Data										
Gain Value	100	177	316	562	1000	1778	3162	5623	10000	15000
Rel Gain (dB)	0	5.11	10.21	14.98	20.03	25.14	29.78	34.71	39.74	43.35
e-/ADU	1.01	0.56	0.31	0.18	0.1	0.06	0.03	0.02	0.01	0.01
Read Noise (e-)	0.79	0.72	0.59	0.54	0.52	0.52	0.5	0.52	0.54	0.52
Full Well (ke-)	4.1	2.3	1.3	0.7	0.4	0.2	0.1	0.07	0.04	0.03
Dynamic Range (stop)	12	11.81	11.08	10.45	9.68	8.96	8.14	7.27	6.44	6.13

Camera setting used for LCG performance analysis is shown below:

- Full resolution
- RAW 12-bit mode
- Temperature: -10°C

Figure 6 shows the curves of the camera analysis data in Table 4

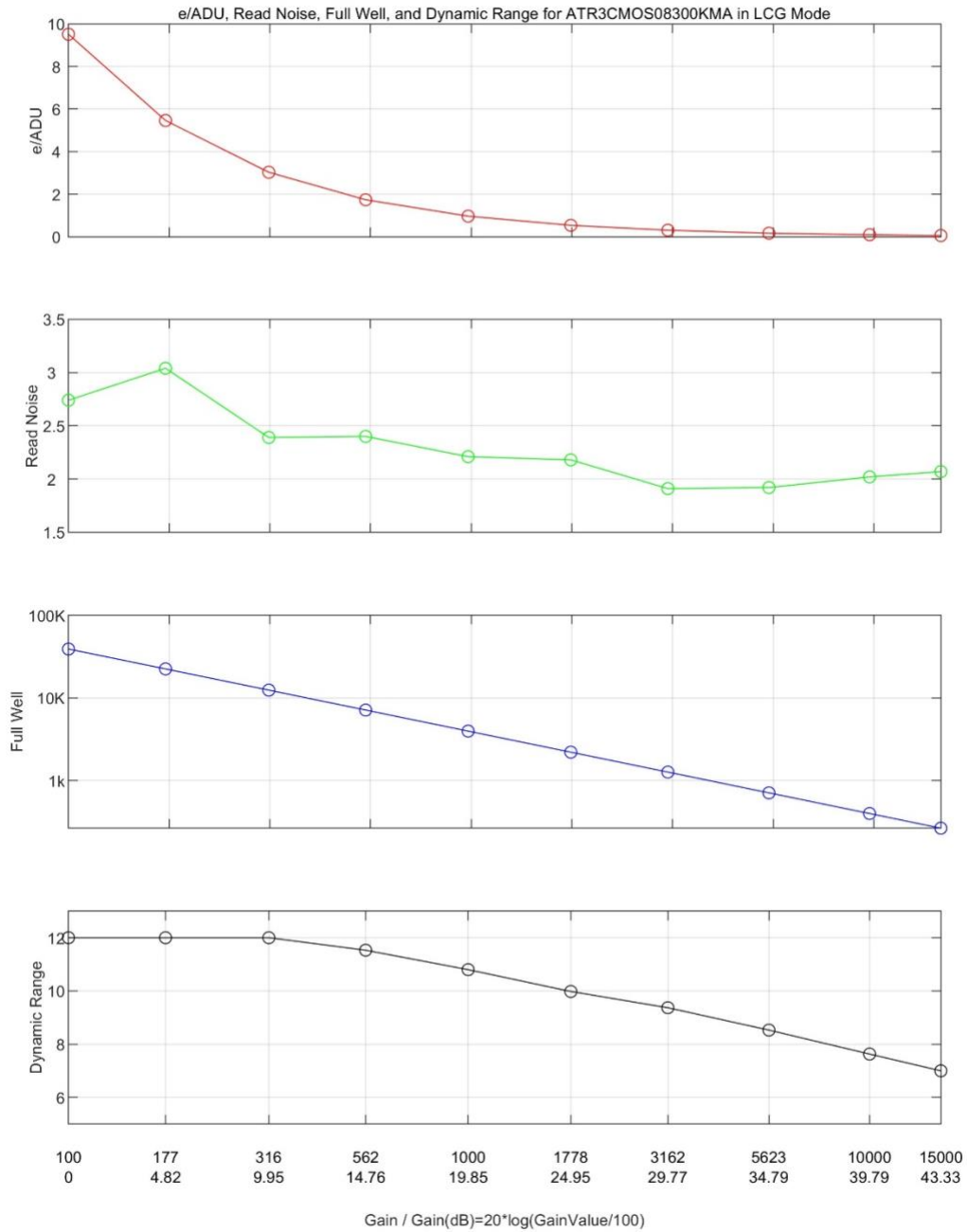

Figure 6 e-/ADU, Read Noise, Full Well and Dynamic Range for ATR585M

The camera analysis data is shown in Table 4:

Table 4 Camera Analysis Data

Sensor Analysis Data										
Gain Value	100	177	316	562	1000	1778	3162	5623	10000	15000
Rel Gain (dB)	0	4.82	9.95	14.76	19.85	24.95	29.77	34.79	39.79	43.33
e-/ADU	9.51	5.46	3.03	1.74	0.97	0.54	0.31	0.17	0.1	0.06
Read Noise (e-)	2.74	3.04	2.39	2.4	2.21	2.18	1.91	1.92	2.02	2.07
Full Well (ke-)	38.9	22.4	12.4	7.1	4	2.2	1.3	0.7	0.4	0.3
Dynamic Range (stop)	12	12	12	11.53	10.8	9.98	9.37	8.53	7.63	7

Camera setting used for HDR performance analysis is shown below:

- Full resolution
- RAW 16-bit mode
- Temperature: -10°C

Figure shows the curves of the camera analysis data in

The camera analysis data is shown in Table 5:

Table 5

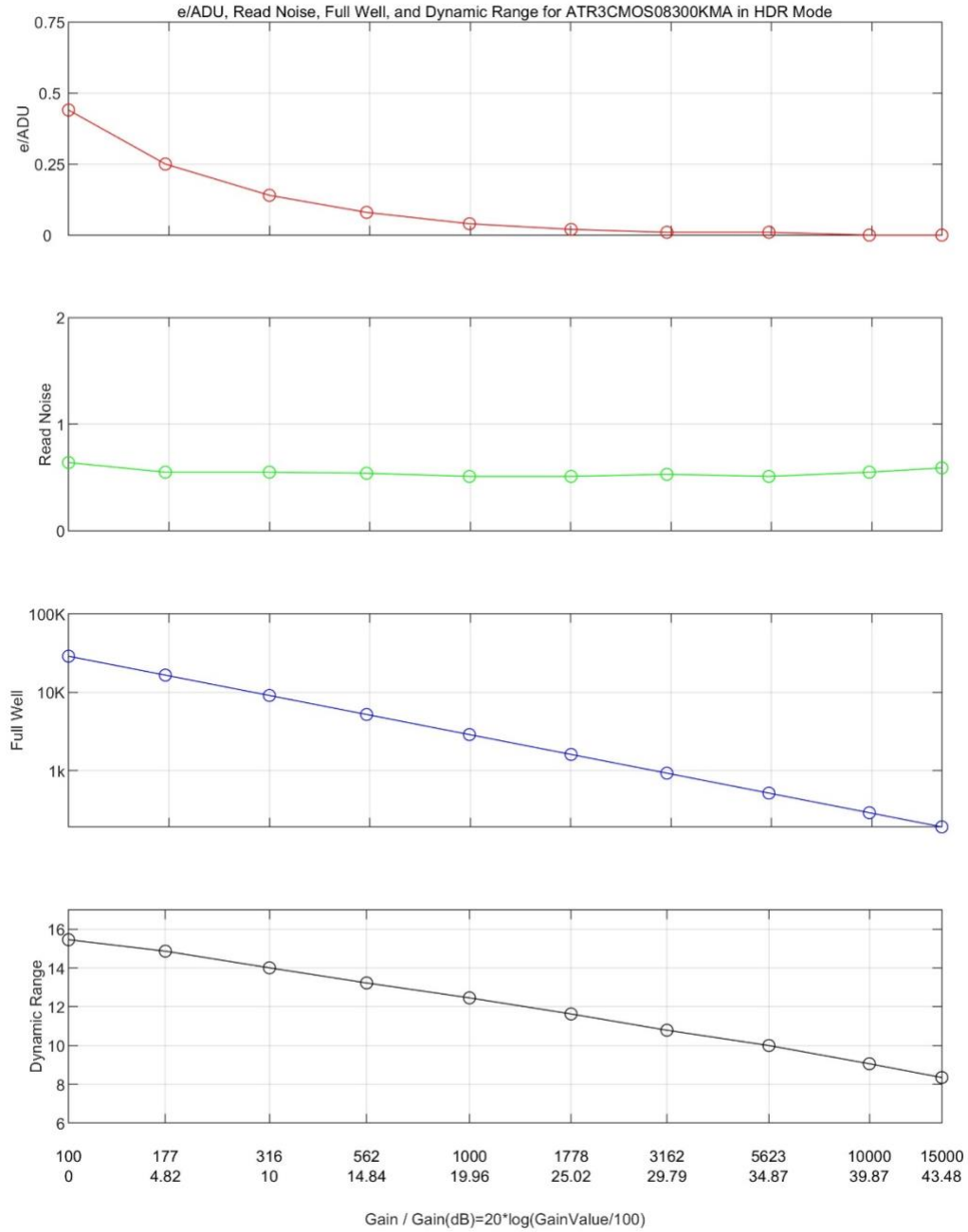

Figure 7 e-/ADU, Read Noise, Full Well and Dynamic Range for ATR585M

The camera analysis data is shown in Table 5:

Table 5 Camera Analysis Data

Sensor Analysis Data										
Gain Value	100	177	316	562	1000	1778	3162	5623	10000	15000
Rel Gain (dB)	0	4.82	10	14.84	19.96	25.02	29.79	34.87	39.87	43.48
e-/ADU	0.44	0.25	0.14	0.08	0.04	0.02	0.01	0.01	0	0
Read Noise (e-)	0.64	0.55	0.55	0.54	0.51	0.51	0.53	0.51	0.55	0.59
Full Well (ke-)	28.7	16.5	9	5.2	2.8	1.6	0.9	0.5	0.3	0.2
Dynamic Range (stop)	15.46	14.87	14.01	13.23	12.46	11.63	10.79	10	9.06	8.35

3 Product Package and Connections

3.1 Packing List

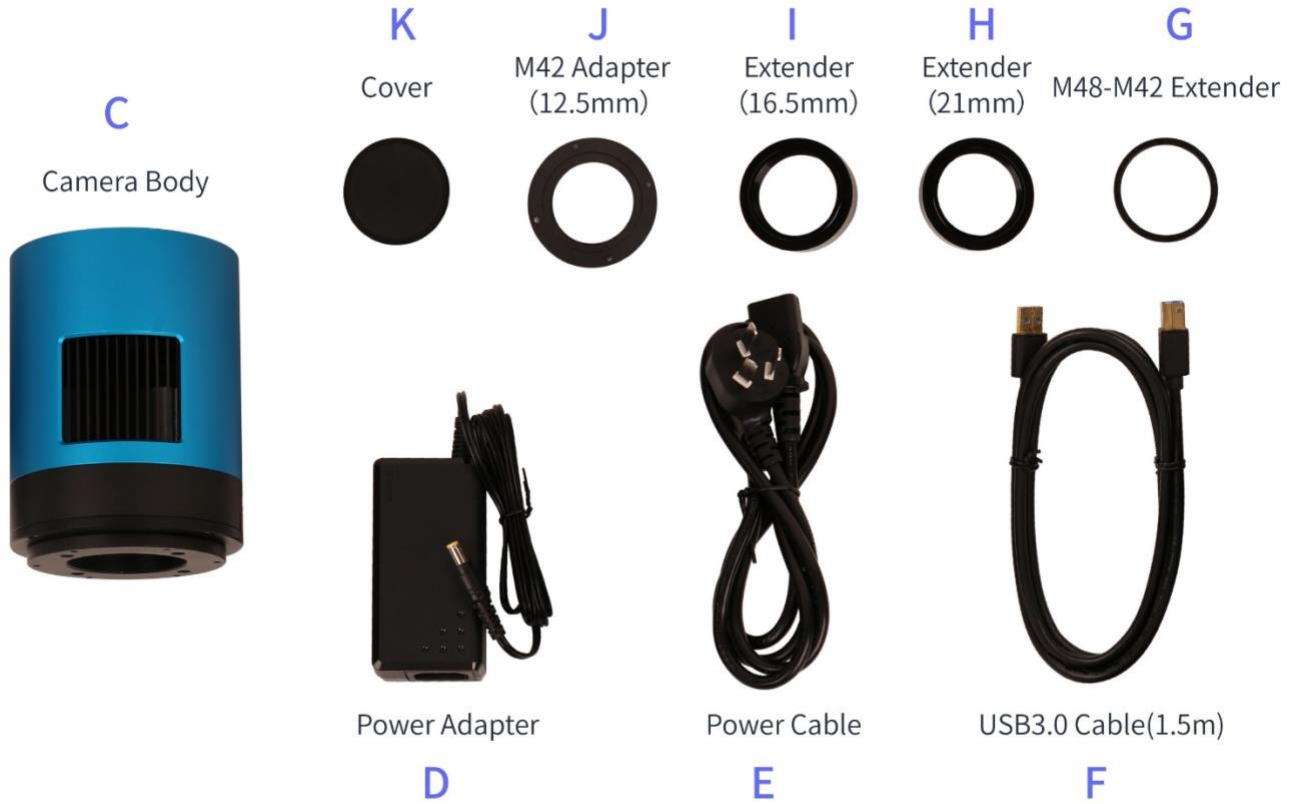

Figure 8 Packing Information of ATR585M

Table 6 ATR585M Packing List

Standard Package	
A	Carton L:50cm W:30cm H:30cm (20pcs, 12~17Kg/ carton, 0.045m3), not shown in the photo
B	3-A safety equipment case: L:28cm W:23cm H:15cm (1pcs, 3.9Kg/ box); carton size: L:28.2cm W:16.7cm H:25.5cm , not shown in the photo
C	ATR series camera (M42x0.75 Mount+2” adapter)
D	Power adapter: input: AC 100~240V 50Hz/60Hz, output: DC 12V 3.3A
E	Power cable
F	High-Speed USB3.0 A male to B male gold-plated connectors cable /1.5m
G	M48-M42 extender 0mm
H	M42M-M42F extender 21mm
I	M48F - M42M extender 16.5mm
J	M42M adapter 12.5mm
K	Cover

3.2 Camera Dimension and Its Mount

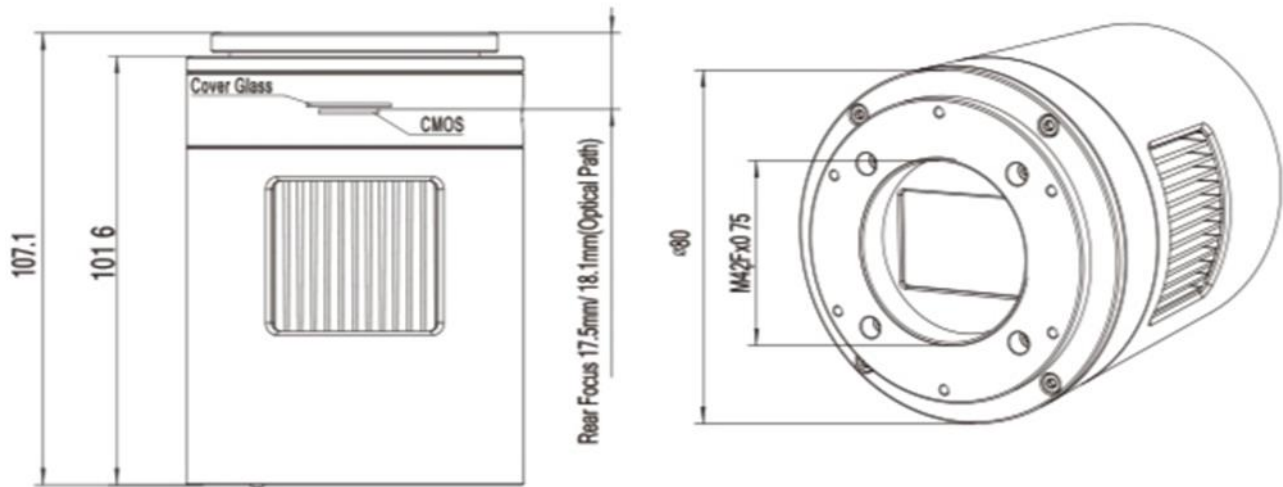

Figure 9 Dimension and Mount of ATR585M

Table 6 Dimension and Mount of ATR585M

Item	Specification
Diameter	$\varnothing 80\text{mm}$
Height	107.1mm
Mount	M4.2F x 0.75mm

3.3 Camera Outline and Interface

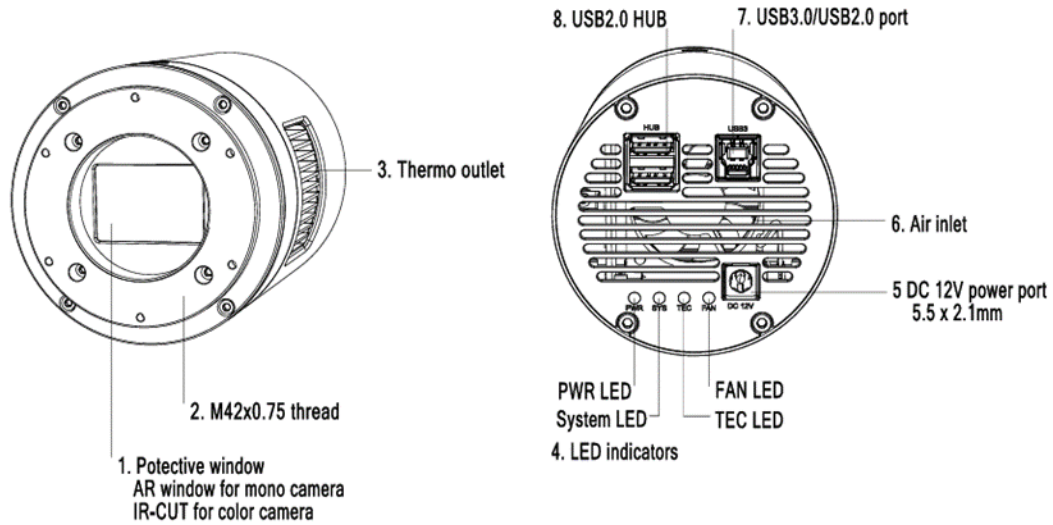

Figure 10 Camera Outline and Interface.

Table 7 Camera Outline and Interface List

Item	Specification
1	Protective window, AR window for mono camera, IR-cut filter for color camera
2	M42F × 0.75 thread
3	Thermal outlet or radiator
4	LED indicators: 1) Power LED. 2) System LED. 3)TEC LED. 4)Fan LED
5	DC 12V 3A power port, 5.5 × 2.1mm
6	Air inlet
7	USB 3.0/ USB 2.0 port
8	USB 2.0 HUB

3.4 Camera Mechanical Connection with Adapter

ATR585M can be connected to a telescope with proper adapter, or the camera lens. The most common adapters are already included in the package, but we also provide some specific adaptors based on the requirement.

The female flange to the sensor is 17.5mm. ATR585M comes with M42x0.75 mount and can connect to telescope with the M42x0.75 thread in a direct way. ATR585M can also connect to the telescope who use 1.25" or 2" eyepieces by M42M-1.25"

or M42M-2” adapter. Figure shows the connection of the camera and the adapter. After the adapter is screwed to the camera, the camera can insert into the telescope’s eyepiece tube. Table 8 list the details of the camera and adapter parameters.

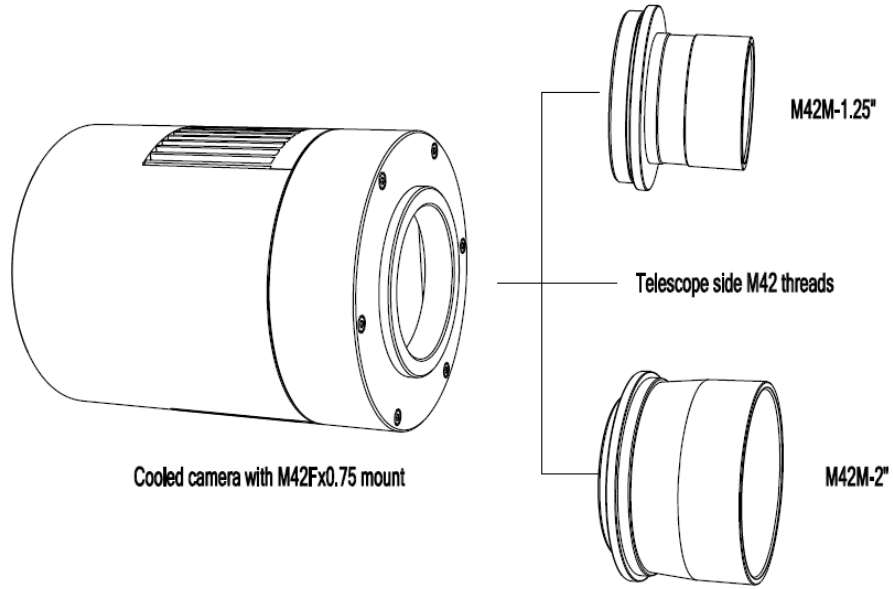

Figure 2 The Connection of the ATR Camera and Adapter

Table 8 Camera and Its Adapter Connections

Item	Specification
Back Focal Distance	17.50mm
M42M-1.25” Adapter	M48M-1.25” adapter for 1.25” telescope
M42M-2” Adapter	M42M-2” adapter for 2” telescope

3.5 Camera Mechanical Connection with Lens

Figure shows the connections of the ATR camera and the lens. Table 9 list the connection’s parameters.

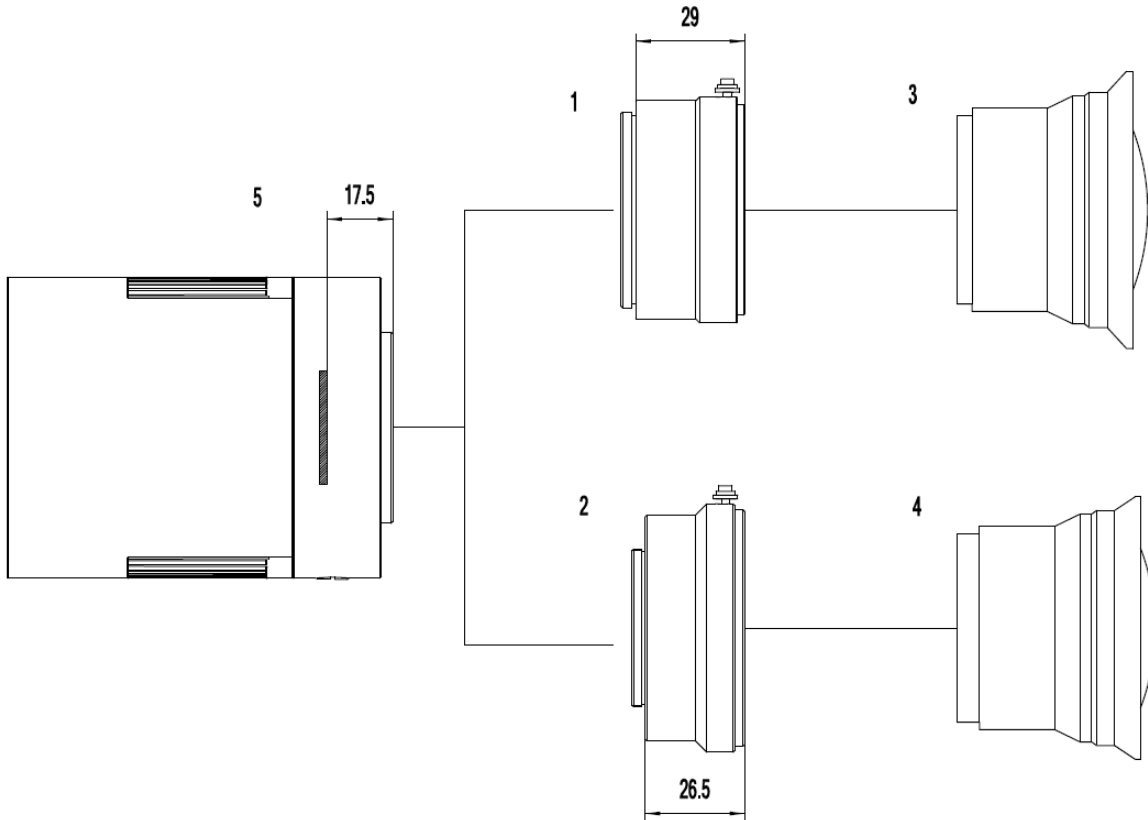

Figure 3 Nikon F/Canon EF Lens with ATR Camera

Table 9 Camera and Lens Connection

Item	Specification
1	Nikon F-M42 adapter
2	EOS EF-M42 adapter
3	Nikon F-mount lens
4	Canon EF-mount lens
5	ATR camera with M42Fx0.75 mount

3.6 Camera Electric Connection with Accessories

On the back side of ATR585M, there are 3 connection ports: DC 12V/3A power port, USB3.0/ USB2.0 port and USB-HUB.

Due to the significantly larger power consumption of IMX585, ATR585M (including the cooling system) is now booted up only by 12V/3A power supply. USB3.0 no longer works as a power source but only as a data communication method. The USB-HUB provides connection with other devices, which allows user to avoid the mess of cable management. Once another device is connected through the USB-HUB, it will be connected to PC device through the USB3.0/USB2.0 port.

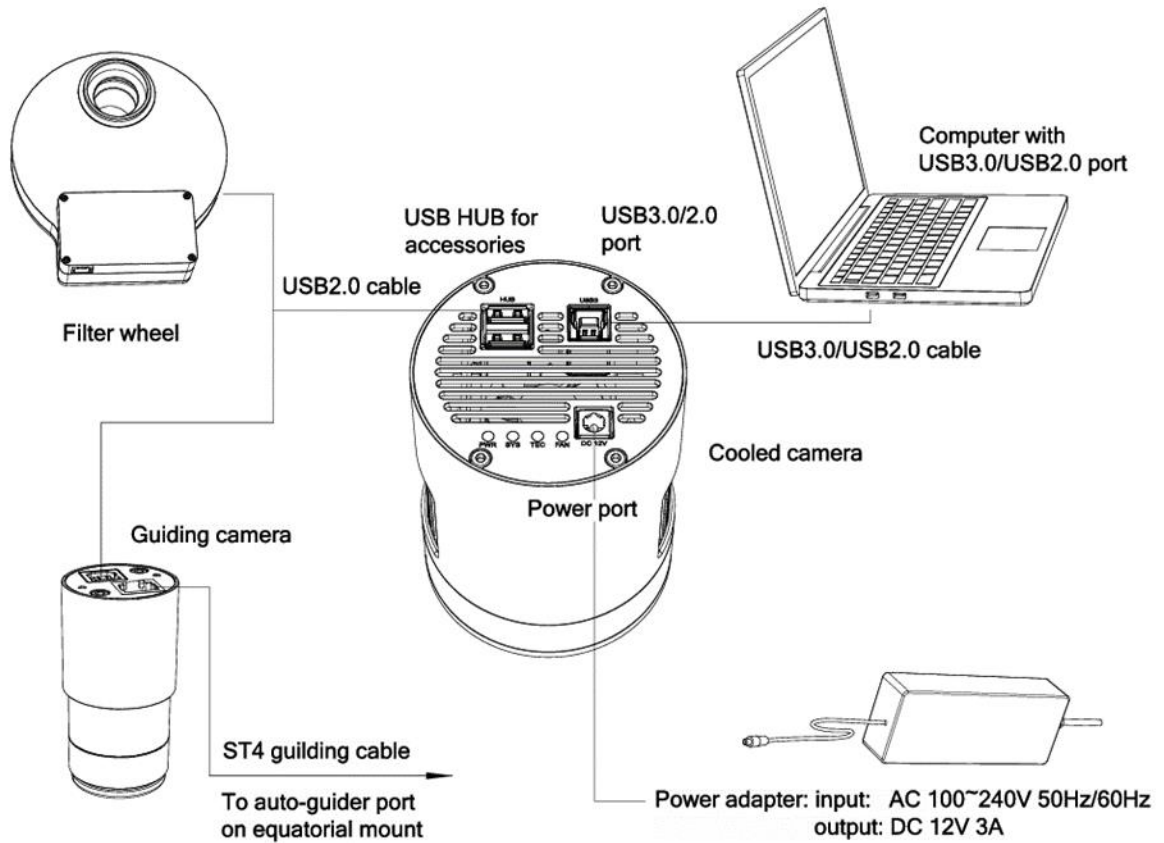

Figure 4 Camera Electric Connection

Table 10 Camera Electric Connection Details

Item	Specification
USB3.0/USB2.0 Port	To computer with USB3.0/USB2.0 cable
USB HUB for Accessories	To filter wheel with USB2.0 cable
	To guiding camera with USB 2.0 cable
Power Port	DC12V/3A

4 ATR585M and Its Software

4.1 Application Installation

For software, customers are welcomed to go to our software website: <https://touptek-astro.com/downloads/>, to download the latest ToupSky. The ATR can also be used with ASCOM, DirectShow SDK. If the third-party software is compatible with these SDK, customers can also download the software driver from our website and install the drivers into the third-party software.

ToupSky is ToupTek astronomy camera's Windows application. ToupSky is a professional software integrated with camera control, image capture & process, image browse, and analysis functions. ToupSky is born with the following features:

Windows:

- x86: XP SP3 or above; CPU supports SSE2 instruction set or above
- x64: Win7 or above

Features

- Full control of the camera
- Trigger mode and video mode support (raw format or RGB format)
- Automatic capture and quick record function
- Multi-language support
- Hardware ROI and digital binning function
- Extensive image processing functions, like image stitching, live stacking, flat field correction, dark field correction, etc.

Supported Camera:

- All ToupTek astronomy cameras

4.1.1 User-friendly UI Design

- Well-arranged menus and toolbars ensure quick operating;
- The unique design of 3 sidebars -- Camera, Folders, Undo/Redo are orderly classified;
- Convenient operating method (Double click or right-click context menu) as much as possible;
- Detailed help manual;

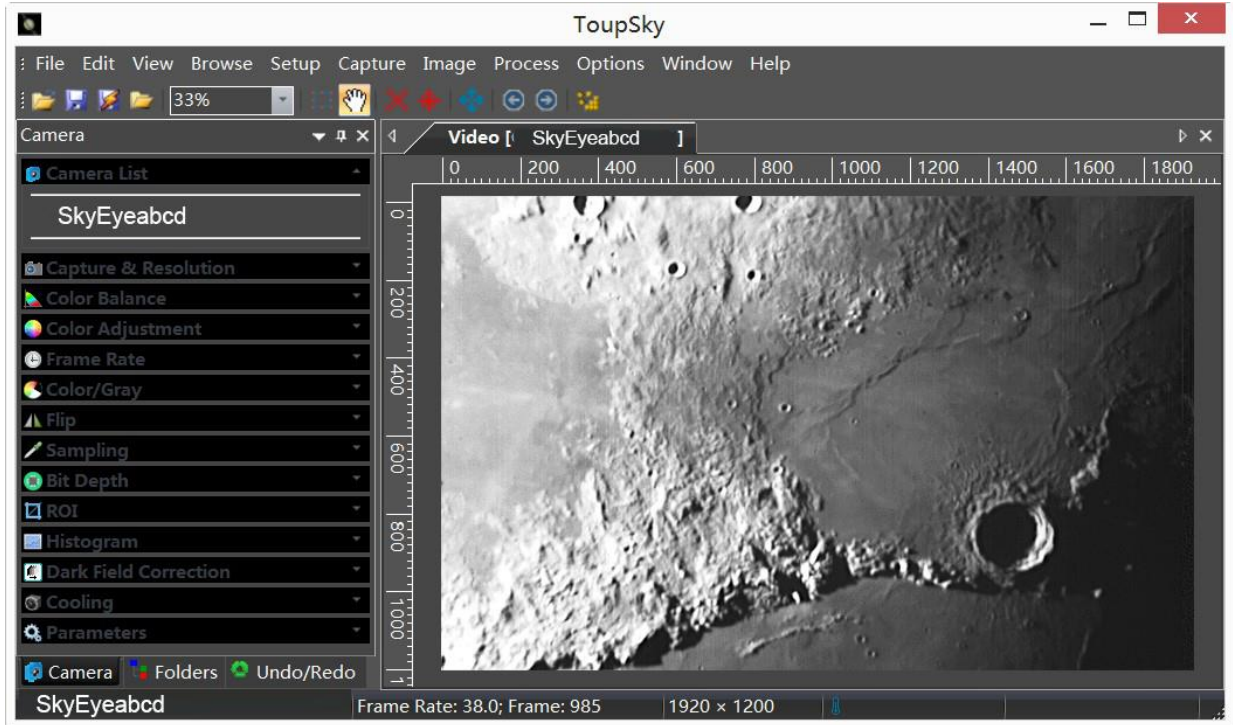

Figure 5 ToupSky and Its Video Window

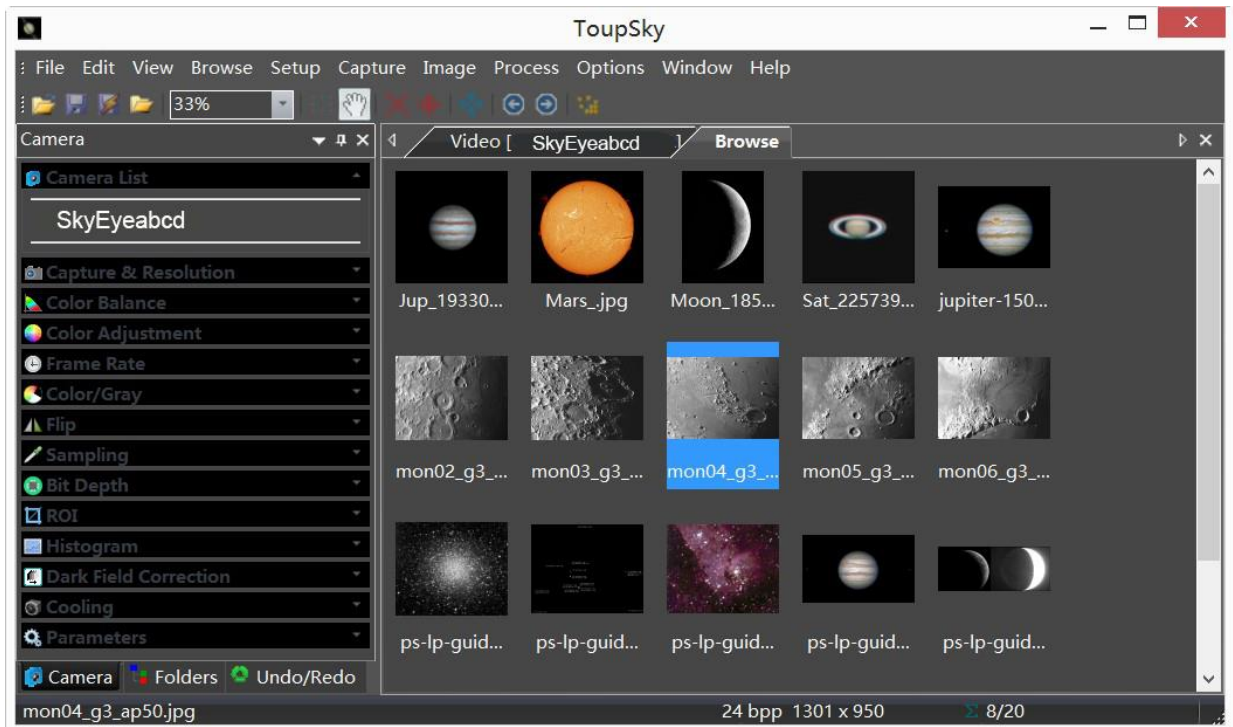

Figure 6 ToupSky and Its Browse Window

4.1.2 Professional Camera Control Panel

Capture & Resolution	Set the live and snap resolution and snap the image or record video;
Exposure & Gain	Auto exposure (exposure target preset) and manual exposure (exposure time can be inputted manually); Up to 5 times gain;

Color Balance	Advanced single-click intelligent white balance setting, temperature and tint can be manually adjusted;
Color Adjustment	Hue, saturation, brightness, contrast, gamma initialization adjustment;
Frame Rate	Adjustment of frame rate available for different computer configurations;
Flip	Check the “horizontal” or “vertical” option to correct the sample direction;
Sampling	Bin mode can obtain low noise video stream; Skip mode obtains sharper and smoother video stream. Support video stream histogram extension, Negative and positive switching, Gray calibration, Clarity factor for focusing etc.
Bit Depth	Switch between 8 bits and 12 bits. 8 bits is the basic Windows image format. 12 bits will have higher image quality but moderate FPS.
ROI	ROI, Region of interest. This function can set the ROI on the video window. When the ROI group was expanded, a dotted rectangle with "Handles" will appear around the video window that will let you alter the ROI. Use mouse button to adjust the ROI size. If ROI is ok, click Apply will set the video to ROI size, Defaults will return to the original size.
Dark Field Correction	To Enable the Dark Field Correction, one should capture the dark field image first. After the images are captured, the Enable button will be clickable. Checking the Enable button will enable the Dark Field correction. Unchecking it will disable the Dark Field Correction.
Cooling	Set the TE-Cooling target temperature and set the fan On/Off;
Parameters	Load, save, overwrite, import, export self-defined parameters of camera control panel (including calibration information, exposure and color setting information);

4.1.3 Practical Functions with Good Results

Video functions	Various professional functions: Video broadcast; Time lapse capture; Video record; Video stream grid; Image stitch; Video scale bar, date etc.
Image Processing and Enhancement	Control and adjust image by denoise, sharpen, color toning deinterlace, all kinds of filtering algorithm and mathematical morphology algorithm, range, binary, pseudo color, surface plot and line profile ital..
Image Stacking	Image stacking adopts advanced image matching technology. With the recorded video, regardless of shifting, rotation, scaling, the high-fidelity image can be stacked to decrease the image noise.

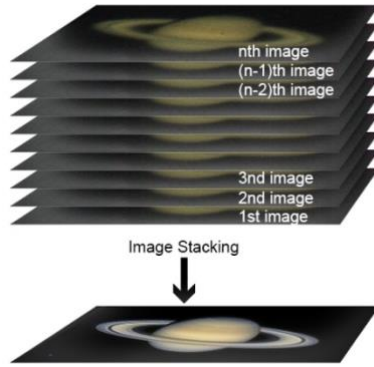

Figure 7 Image Stacking

4.1.4 Powerful Compatibility

Video Interface	Support Twain, DirectShow, SDK Package (Native C++, C#/VB.NET)
Operating System	Compatible with Microsoft® Windows® XP / Vista / 7 / 8 / 10 / 11 (32 & 64 bit), Mac OSX, Linux
Language Support	Unlimited language support, currently available in Simplified Chinese, Traditional Chinese, English, Russian, German, French, Polish and Turkish

4.1.5 Hardware Requirement

PC Requirements	CPU: Intel Core 2 2.8GHz or higher
	Memory:2GB or more
	USB port: USB3.0/USB2.0 port

	Display:17" or larger
	CD-ROM

4.2 ATR585M and Dshow

DshowAstro is an interface driver providing Dshow standard support for ToupTek USB astronomy camera

Supported OS: Windows:

- x86: XP SP3 or above; CPU supports SSE2 instruction set or above
- x64: Win7 or above

Supported Camera:

- All ToupTek astronomy cameras

4.3 ATR585M and the 3rd Party Software

4.3.1 Support Software

No.	Software	Version	WDM	ASCOM	Native
1	PHD Guiding	2.3.0(2014)	√	√	√
2	Nebulosity	3.2.2(2014)	√	×	/
3	MaxIm DL	5.23(2013)	√	×	/
4	SharpCap	2.1(2014)	√	×	/
5	MetaGuide	5.2.0(2014)	√	/	/
6	FireCapture	2.4.05(2014)	√	/	/
7	Astroart	5.0(2014)	√	×	/

4.3.2 N.I.N.A

Powerful open source astronomy equipment management system for deep sky photo shooting, free.

4.3.3 INDI

A popular third-party driver software for astronomy devices, often used on Linux and MacOS.

4.3.4 ASCOM Platform

All AstroCam telescope camera drivers request to install ASCOM platform, free.

<http://www.ascom-standards.org/index.htm>

You can download the ASCOM package from : <http://ascom-standards.org/Downloads/Index.htm>

4.3.5 PHD Guiding

A popular free guide software: <http://openphdguiding.org/>

ToupTek's telescope camera support Native/ASCOM/WDM driver to run the video.

4.3.6 Nebulosity

A popular cooled camera control/image process software directly supported via ASCOM.

4.3.7 MetaGuide

Autoguiding software with novel method to avoid the atmospheric agitation. The latest version support GCMOS01200KPB and the guide port: <http://www.astrogeeks.com/Bliss/MetaGuide/>

4.3.8 MAXIMDL

Famous full functional CCD Control/Image Process software. Popular used in US.

4.3.9 AstroArt

Famous full functional CCD Control/Image Process software. Popular used in Europe.

4.3.10 FireCapture

Great free planetary capture software. Support part of AstroCam series telescope camera.

4.3.11 SharpCAP

A nice free planetary capture software support WDM cameras includes AstroCam series telescope camera.

4.3.12 Registax

A popular free planetary stacking and processing software.

4.3.13 AstroStack

A planetary stacking and process software.

4.3.14 DeepSky Stacker

A free deep sky image stack and process software.

5 Service

For software upgrades, please refer to “Download” on our official website: <https://touptek-astro.com/>

For customers who purchase the cameras from local dealer, please contact your dealer for more inquiry.

For technical support, please contact e-mail address: astro@touptek.com.